

FORD

SERIES 730
LOADER

01
96
9010/11
74

OPERATOR'S MANUAL



FORD TRACTOR DIVISION
FORD MOTOR COMPANY

TABLE OF CONTENTS

	<i>Page</i>
GENERAL INFORMATION	4
CONTROLS	5
PRE-OPERATION	6
OPERATION	6
Filling the Bucket	6
Carrying the Load	7
Lifting the Load	7
Dumping the Bucket	7
Lowering the Bucket	8
Operating with Float Control (Components 19-513 and 19-516)	8
Loading from a Bank	8
Loading from a Stockpile	9
Peeling and Scraping	9
Backfilling	10
Breaking and Spreading Large Piles	11
SAFETY PRECAUTIONS	12
SHIFTING TECHNIQUES	12
ATTACHMENTS	13
ATTACHMENT INSTALLATION	16
LUBRICATION	16
LOADER HYDRAULIC SYSTEM MAINTENANCE	17
Checking Hydraulic Oil Level	18
Cleaning Oil Breather Cap	18
Draining Hydraulic Oil and Changing Oil Filter	18
LOADER REMOVAL AND STORAGE	20
SPECIFICATIONS	22
MAINTENANCE RECORD	26

GENERAL INFORMATION

This manual contains information pertaining to the Series 730 Loaders. Four Series 730 Loaders are available. These loaders are identified by component numbers as follows:

- 19-427 Frame with single-acting lift cylinders and control valve
- 19-512 Frame with double-acting lift cylinders and control valve
- 19-513 Frame with double-acting lift cylinders and control valve with float position
- 19-516 Frame with double-acting lift cylinders and compensating (self-leveling) control valve with float position and attached selector valve

On Loader Component 19-513, the loader control valve incorporates a bucket float feature that permits the bucket to freely follow the contour of the working surface.

On Self-Leveling Loader Component 19-516, the loader control valve incorporates a bucket self-leveling feature in addition to a bucket float feature. The self-leveling action of the control valve keeps the bucket positioned so as to avoid spillage when lifting the load. As the loader lift arms are raised, the bucket slowly rolls forward to maintain approximately the original degree of bucket rollback from ground level to full height. Attached to the side of the loader control valve is a selector valve that permits the operator to either bypass or make use of the self-leveling feature of the loader.

Figure 1 illustrates a Ford Series 730 Loader installed on a Ford 3400 Tractor.

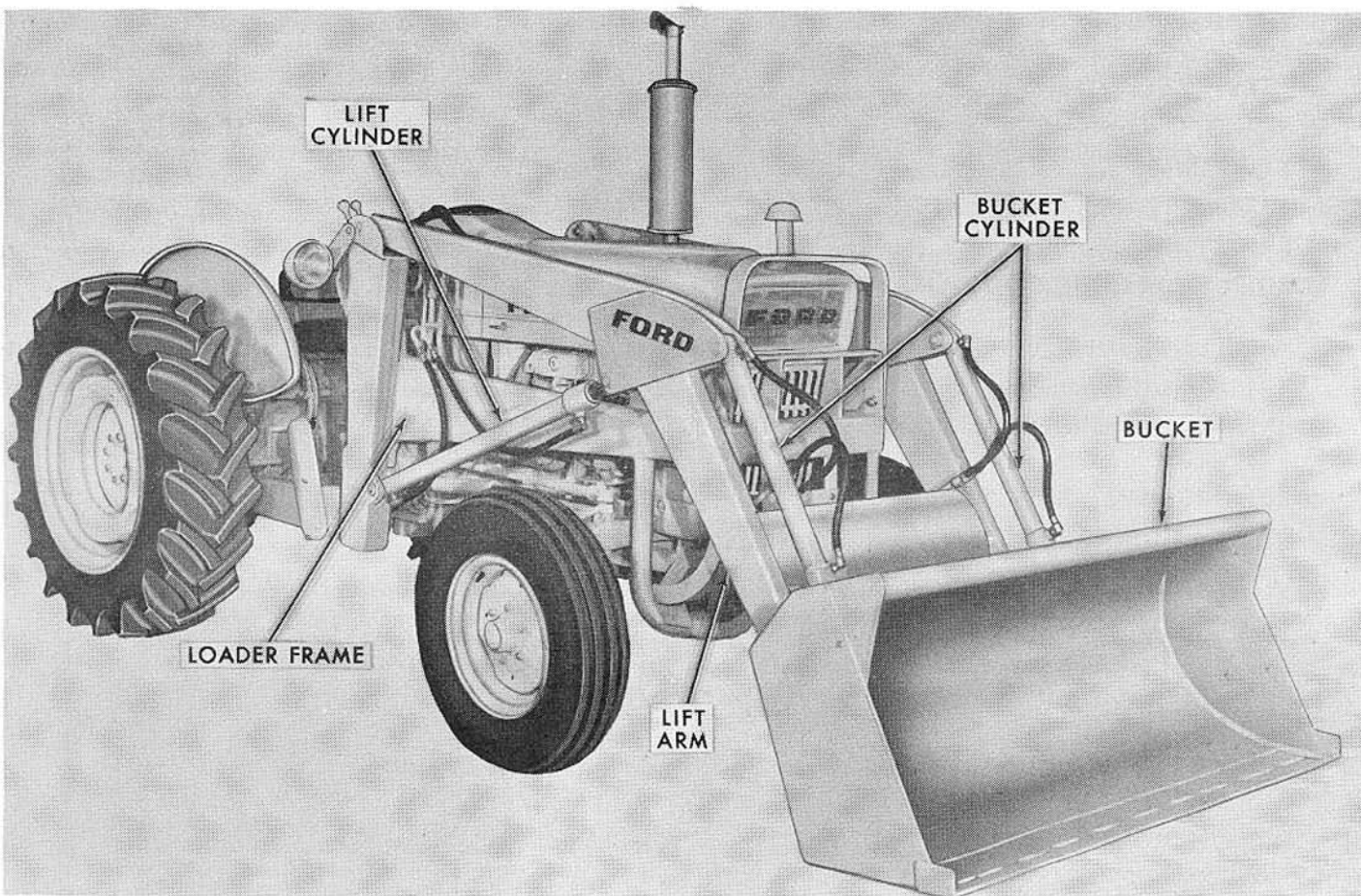

Figure 1
Series 730 Loader Installed on Ford 3400 Industrial Tractor

CONTROLS

The loader is controlled by two levers: a lift lever and a bucket lever, as shown in Figure 2. The lift lever controls the raising and lowering of the lift arms. The bucket lever controls the rollback and dumping of the bucket.

In addition to the four basic movements, a lift arm float position can be obtained on Loader Components 19-513 and 19-516 by moving the lift arm control lever forward into the detent position. The levers can be "feathered" (moved slightly) in all positions except float, to give you precise bucket control.

A selector valve, attached to the control valve on the Self-Leveling Loader, Component 19-516, permits the operator to bypass the self-leveling action of the control valve, if desired. The operation of the selector valve is such that when the knob is pushed in, the loader will not self-level. When the knob is pulled out, the loader bucket will self-level as the lift arms are raised.

Study the movement of the loader control levers so you can effectively operate the loader and develop efficient operating techniques. The easiest way to remember the various lever positions is to relate bucket movement to yourself while sitting in the tractor seat.

The following chart illustrates the various combinations of lift arm and bucket action that may be obtained when moving the control levers to the different positions.

Lever Movement	Lift Lever	Bucket Lever
Forward (Away From You)	Bucket Drops*	Bucket Dumps
Further Forward Locks In Float Position †	Bucket Follows Contour of Surface †	—
Release (Neutral)	Bucket Will Not Drop	Bucket Remains In Position
Rearward (Toward You)		
Non-Self- Leveling Loaders	Bucket Raises	Bucket Rolls Back
Self-Leveling Loaders	Bucket Raises and Self-Levels **	Bucket Rolls Back

* **Single-Acting Lift Cylinders (Component 19-427):**
The bucket will drop from its own weight, but no down pressure will be exerted on the bucket if the lever is held in the forward position.

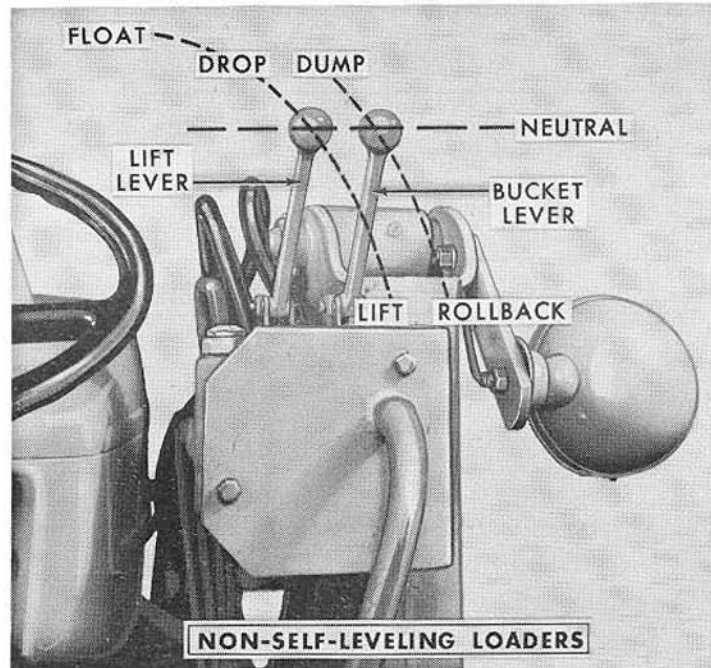
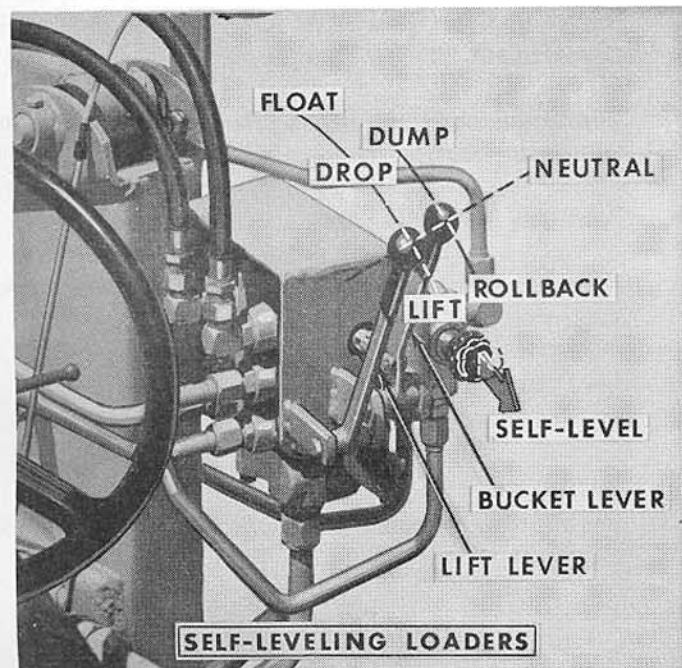

Figure 2
Control Lever Positions

OPERATION

- * **Double-Acting Lift Cylinders (Component 19-512):** Holding the lift lever in the forward position will provide hydraulic down-pressure on the bucket, permitting up to four inches of below-grade digging with a level bucket.
- † **Double-Acting Lift Cylinders and Control Valve with Float Position (Components 19-513 and 19-516):** Moving the lift lever forward, as far as possible to the float position, allows the bucket to follow the contour of the working surface. The float position keeps the bucket on the ground without any down pressure, because both ends of the lift cylinders are hydraulically connected to allow them to move freely up or down. The lever locks in float position and must be manually moved to another position.
- ** **Double-Acting Lift Cylinders and Control Valve with Float Position and Selector Valve (Component 19-516):** The bucket will self-level only if the selector valve knob is pulled out. The self-leveling action of the loader will be bypassed if the selector valve knob is pushed in.

PRE-OPERATION

Before putting the loader in operation, it is necessary to add additional counterbalance weight to the rear of the tractor for safe operation. Add weight to the rear in the amounts shown in the following chart:

Tractor	Weight To Be Added
2100 *	2000 to 5000 pounds
2120	2000 pounds <i>minimum</i>
2130	2000 pounds <i>minimum</i>
3100 *	2000 to 5000 pounds
4120	2000 pounds <i>minimum</i>
4130	2000 pounds <i>minimum</i>
3400 *	2000 to 5000 pounds

* For optimum performance on the Ford 2100, 3100, and 3400 Tractors, obtain a total rear wheel reaction of 6000 pounds. Rear wheel reaction includes the actual weight of the tractor and any added counterbalance weight measured at the rear wheels.

Obtain this weight by using rear wheel weights, liquid ballast, or rear attached equipment.

If wheel weights and/or liquid ballast are used, the actual weight added equals the effective counterbalance weight. Example: 2400 pounds of added wheel weights or liquid ballast equals 2400 pounds of effective counterbalance weight.

When a Ford Series 750 or 753 Backhoe is attached to the tractor the effective counterbalance weight is:

- Series 750 Backhoe 4275 pounds
- Series 753 Backhoe 4620 pounds

The effective counterbalance weight of other rear attached equipment is determined by multiplying the actual weight of the equipment by 1.50. Example: Equipment weighing 800 pounds attached to the rear of the tractor multiplied by 1.50 equals 1200 pounds of effective counterbalance weight.

OPERATION

The loader should be operated with the tractor engine running at 1200–1700 rpm. Excessive speeds are dangerous, and may cause bucket spillage and unnecessary strain.

When operating in temperatures below 30° F., run the tractor engine below 1200 rpm until the oil temperature exceeds 30° F.

The following illustrations offer suggested operating techniques for your consideration.

FILLING THE BUCKET

Approach and enter the pile with a level bucket.



Ease both levers back to lift and roll back the bucket.

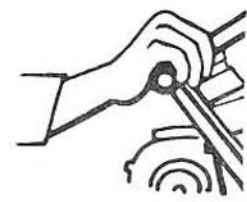

OPERATION

The lift and rollback of the bucket will increase efficiency because

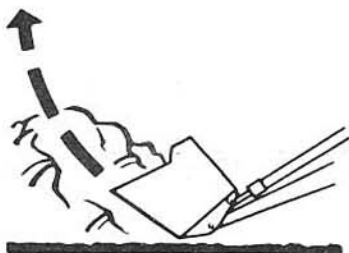

a level bucket throughout the lifting cycle resists bucket lift or breakaway.



NOTE: If the bucket is not completely filled, do not waste time by trying to load additional material in the bucket. Maximum productivity is determined by the amount of material loaded in a given period of time. Time is lost if two or more attempts are made to fill the bucket on each pass.

CARRYING THE LOAD

Position the bucket just below the level of the tractor hood, for maximum stability and visibility, whether the bucket is loaded or empty.

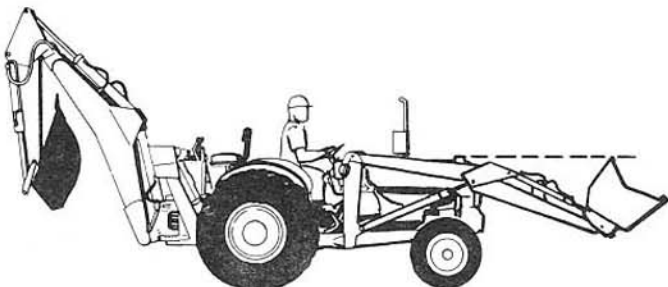

When operating the loader on a hill or slope, keep the bucket as low as possible. This keeps the bucket center of gravity as low as possible. This will give you maximum tractor stability.

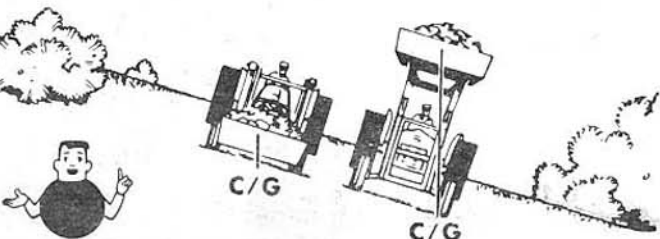

When transporting the load, keep the bucket as low as possible to resist tipping, in case a wheel drops in a rut.



LIFTING THE LOAD

When lifting the load, keep the bucket positioned so as to avoid spillage. On self-leveling loaders, pull the selector valve knob "OUT". The self-leveling action of the loader automatically positions the bucket to retain the full load as the loader lift arms are raised.

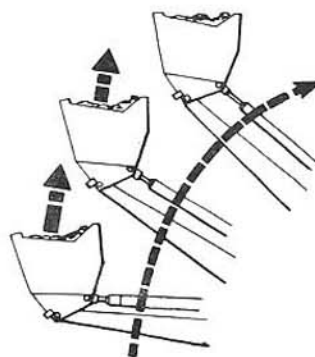

NOTE: Do not attempt to lift bucket loads in excess of the loader capacity.

DUMPING THE BUCKET

Lift the bucket high enough to clear the side of the vehicle. Move the tractor in as close to the side of the vehicle as possible, then dump the bucket.



LOWERING THE BUCKET

After the bucket is dumped, back away from the vehicle while lowering and leveling the bucket.

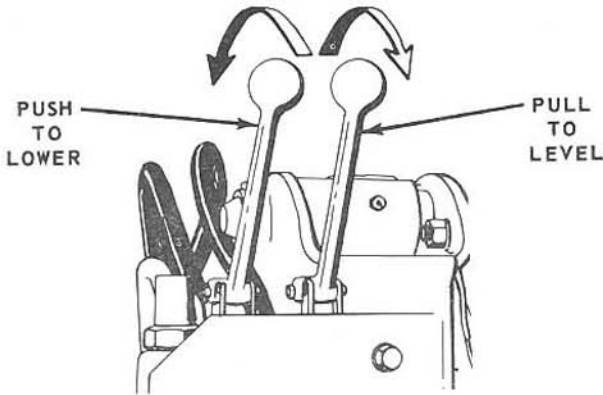

OPERATING WITH FLOAT CONTROL (COMPONENTS 19-513 AND 19-516)

During hard surface operation, keep the bucket level and put the lift lever in the float position to permit the bucket to float on the working surface. If hydraulic down pressure is exerted on the bucket it will wear faster than normal.

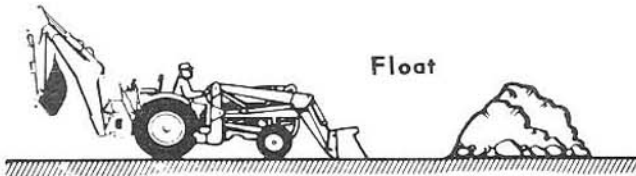

The float position will also prevent the mixing of surface material with stockpile material. The float position will reduce the chance of surface gouging when removing snow or other material, or when working with a blade or broom.

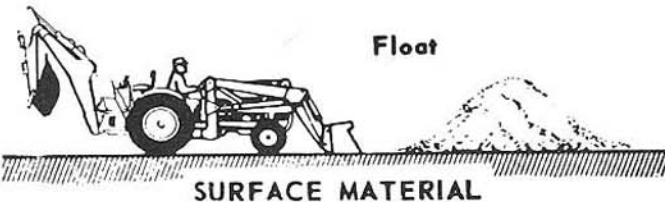

LOADING FROM A BANK

Choose a forward gear that provides sufficient ground speed for loading.

For faster loading, maintain a 45° turn angle, and work as close to the truck as possible.

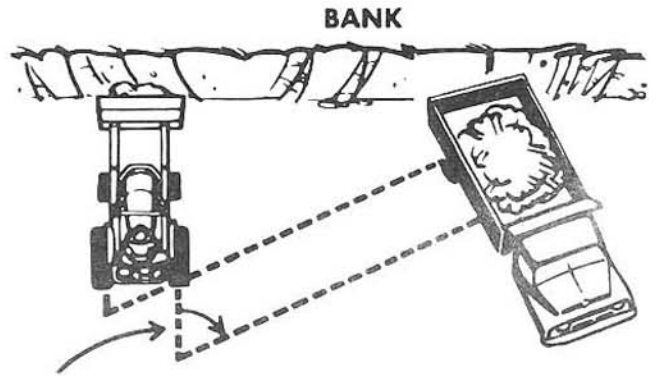

Keep the surface from the bank to the truck free of ruts and holes.

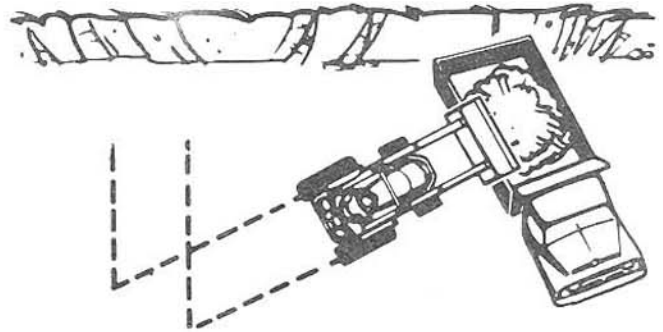

Backgrade with the bucket occasionally, and approach the back with the bucket flat. Slight down pressure with the bucket level helps keep the working area smooth. Use the heel or lower rear edge of the bucket for backgrading ruts, etc.

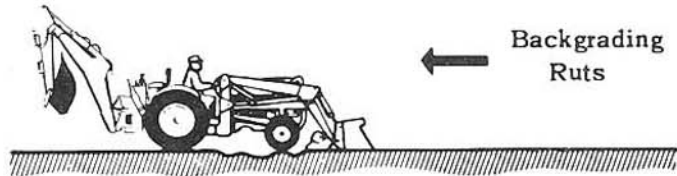

Always keep the truck close to the operation and keep the cutting depth about half the length of the truck bed.

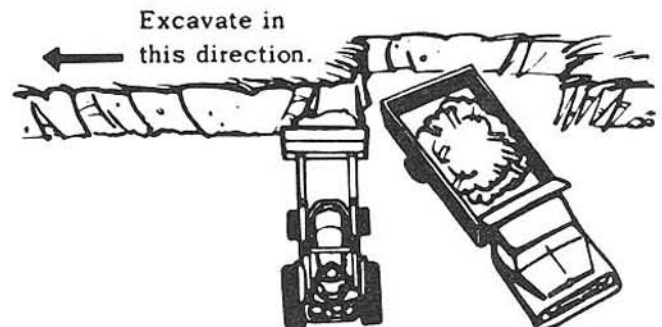

OPERATION

Exercise caution when undercutting high banks. Soil slides can be dangerous. Load from the bank as low as possible for maximum efficiency.

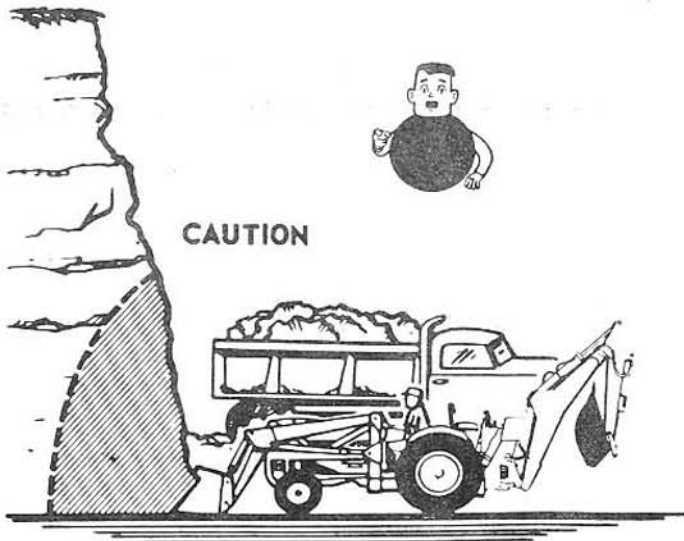

Keep an area clean for the truck to back into, as close to the work area as needed. This will minimize the travel distance from the pile to the truck.

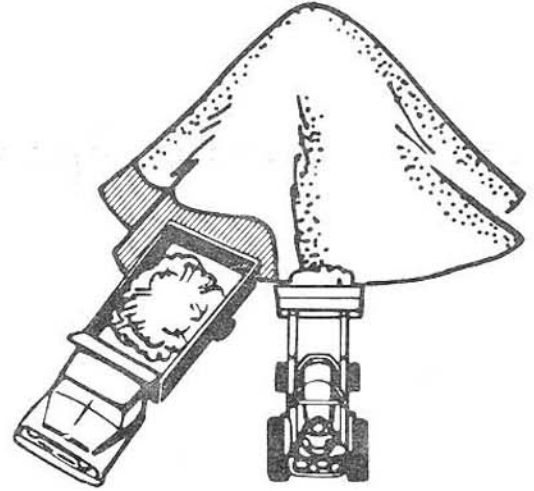

Keep the truck in close and work around the pile.

Remember that the loader lift and breakaway capacities diminish rapidly as loading height is increased.

LOADING FROM A STOCKPILE

Initially approach the stockpile with the bucket approximately two feet off of the ground. The bucket may be operated at a lower position when the stockpile height has been reduced so the bucket will break out easily at ground level.

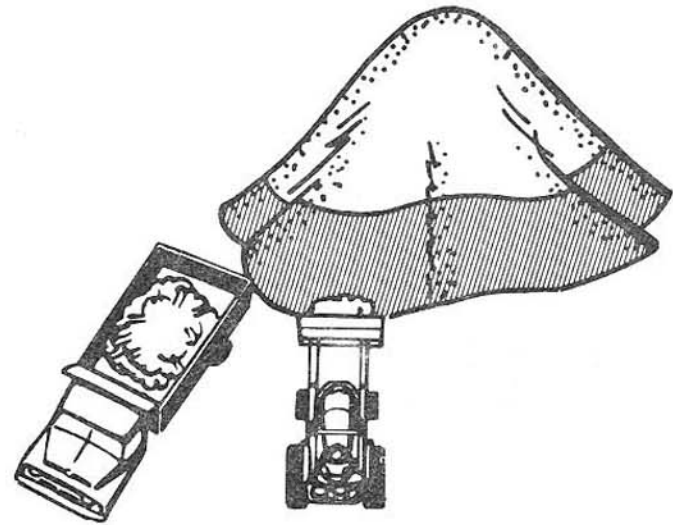

PEELING AND SCRAPING

Push the selector valve knob "IN" on self-leveling loaders to prevent the self-leveling action of the control valve from operating during peeling and scraping operations.

Use down pressure and a slight bucket angle to start long cuts. Make a short angle cut and break out cleanly.

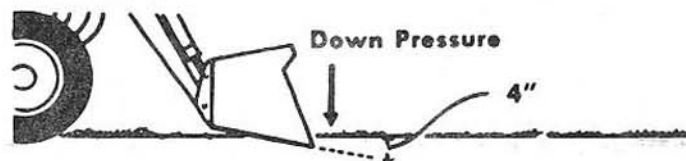
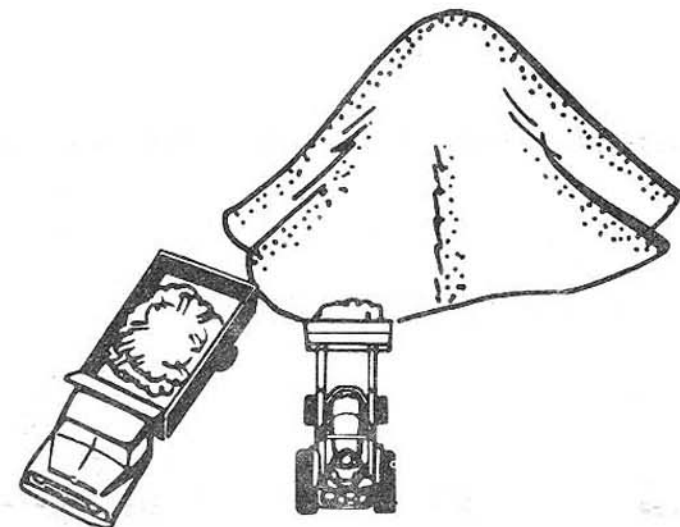

OPERATION

With the bucket level, start a cut at the notch approximately two inches deep. Hold the depth by feathering the bucket lever to adjust the cutting lip up or down. When the front tires enter the notch, adjust the lift and bucket lever to maintain proper depth.

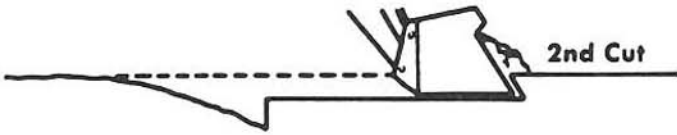

Make additional cuts until the desired depth is reached.

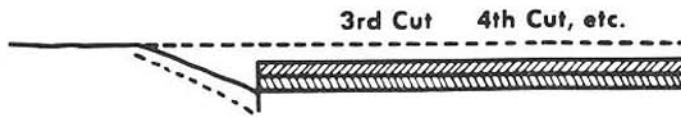

During peeling operations, use lift cylinder down pressure and a slight bucket angle for penetration to the desired working depth. After reaching the desired working depth, use only the bucket lever, leaving the lift lever in either the float or neutral position. This allows the operator to control the bucket angle and maintain a precise cut.



If the lift lever is used without controlling the bucket angle, the bucket will gouge and leave a series of ruts in the surface.

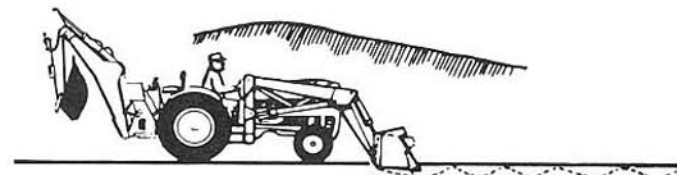

BACKFILLING

On self-leveling loaders, push the selector valve knob "IN" to bypass the self-leveling action of the control valve during backfilling operations.

Efficient backfilling occurs when the tractor pushes the maximum amount of soil without losing speed or traction. If the tractor slows, reduce the width of cut. If the tractor is not working at capacity, increase the width of cut.

Approach the pile with a level bucket. When adjusting the cut to a load that the tractor can push, actuate the lift lever and maintain a level bucket.

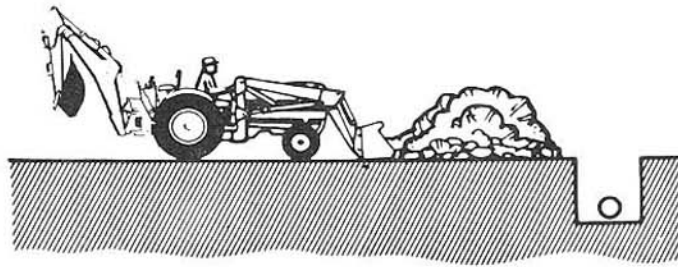

Leave the soil in the bucket because dumping on each pass wastes time. Lift and level the bucket for the next pass while backing from the excavation.

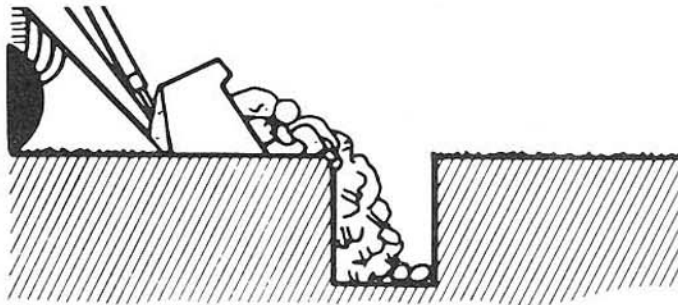

Operate at right angles to the ditch. Take as big a bite as the tractor can handle without lugging the engine.

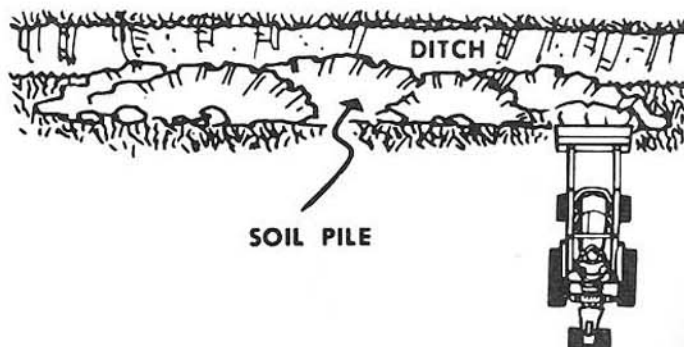

Leave the soil which drifts over the side of the bucket for final cleanup.

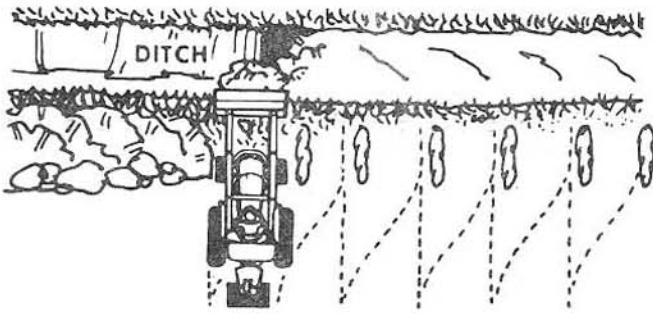

When backfilling on a slope, have the soil piled on the high side for easier backfilling.

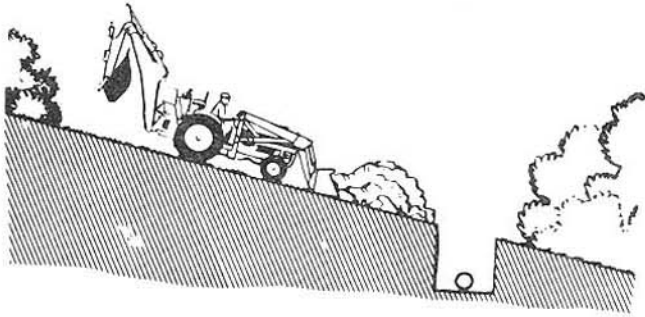

If stuck in the ditch . . .

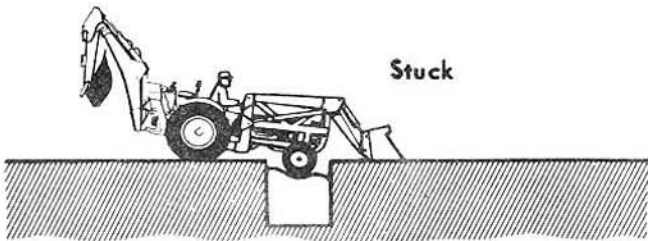

. . . dump the bucket and apply down pressure to lift the front wheels out of the ditch. To move the tractor backward, operate the bucket lever as tractor power is applied.

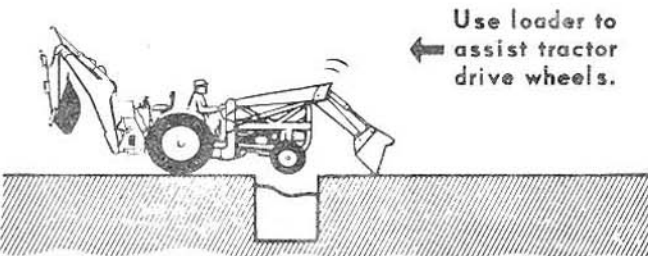

When backfilling from a large pile, shovel off the top of the pile, pushing toward the excavation. Drag some soil backward to form a work ramp of convenient grade.

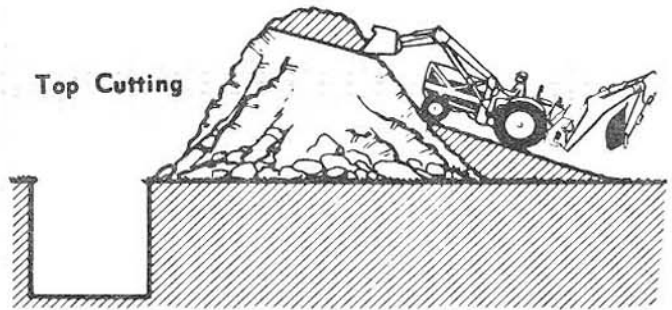

BREAKING AND SPREADING LARGE PILES

Sidecutting is a good technique for cutting down a large stockpile.

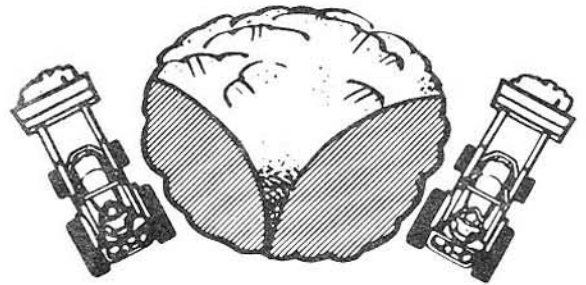

If the sides of the pile are too high, use the loader to pull down the sides and to reduce the possibility of stockpile slides.

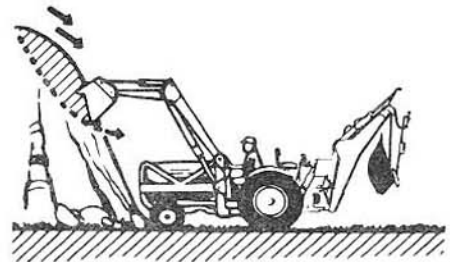

Then, build a ramp by shovel-loading material off the top, until a work area is cut through the pile.



SHIFTING TECHNIQUES

SAFETY PRECAUTIONS



Do not allow anyone but the operator to ride on the tractor—loader.

Do not make mechanical adjustments while the unit is in motion.

Do not attempt to repair or tighten hydraulic hoses when under pressure, when the tractor engine is running, or when the lift arms are raised.

Do not dismount from the tractor and leave the loader lift arms raised.

Do not get under the bucket or lift arms or reach through the lift arms when the loader is raised.

Do not leave the tractor—loader when it is in motion.

Always shut off the engine when leaving the tractor.

Do not tow the tractor faster than 20 mph.

When parking, make sure the parking brakes are set or the Select-O-Speed transmission is in "park" position.

Place adequate counterweight on the rear of the tractor so that the unit is stable.

Exercise extreme caution when operating the tractor with a raised loaded bucket or fork.

The following shifting techniques are of special interest to Select-O-Speed transmission operators; however, some of these techniques will be helpful for manual transmission operators. Manual transmissions have a clutch pedal instead of an inching pedal.

In order to take advantage of the Select-O-Speed transmission, it is necessary to understand and practice the technique of "shuttle shifting".

1. Install the selector lever and neutral bypass plate on the left side of the selector mechanism. See the "OPERATION" section of your Tractor Operator's Manual for instructions on relocating the selector lever.
2. Install the speed stop screws in the bypass plate to limit the selector lever travel between 5th and R₂.

SHIFTING

1. Approach the pile with your right hand on the loader levers, and after establishing the forward direction, keep your left hand on the selector lever.
2. Maintain engine rpm as the bucket enters the pile. Engine rpm can be maintained by downshifting or increasing the throttle setting.

Engine rpm must be maintained to keep the hydraulic pump operating at capacity.

3. Pull both loader levers to pry and lift with the bucket. See the illustrations for filling the bucket in the "OPERATION" section, page 6.
4. When the bucket is loaded, push down on the inching pedal and snap the selector lever down to reverse. Ease up on the pedal and back out.
5. Back out far enough to make an easy swing to head for the truck. Then, push down on the inching pedal and the brake pedal; snap the selector lever up to a forward gear; release the brake, and ease up on the inching pedal to start forward.

ATTACHMENTS

6. Raise the bucket to clear the truck body.
7. Drive in close to the truck.
8. Dump the bucket while pushing down on the inching pedal and selecting reverse.
9. Back away from the truck. While backing away, roll back and lower the bucket simultaneously, so the bucket is level when you approach the pile.

Continued use and practice of these procedures will enable you to achieve smooth, fast, and efficient loader operation.

ATTACHMENTS

A variety of attachments, especially designed for industrial operations, are available for use on the Ford Industrial Loader. These attachments are sold separately by your Ford Tractor—Equipment Dealer.

Ford Buckets have several construction features that make them outstanding. Note the following features, then order the bucket (or buckets) you need, through your Ford Tractor—Equipment Dealer.

- The backs of the buckets are curved for easier filling.
- The tops of the buckets are reinforced for greater strength.
- The bottoms are reinforced and equipped with 3/8" wear straps for longer life.
- The tops of the buckets have spill guards to protect the operator when the bucket is raised for high loading operations.

An illustration and brief description of each available attachment is listed below.

19-99 Light Material Bucket: 3/4 Cu. Yd. ➔

Cutting Width: 73-1/4 inches
Inside Height: 26-3/4 inches
Depth: 25-1/2 inches
Weight: 365 pounds (approximate)

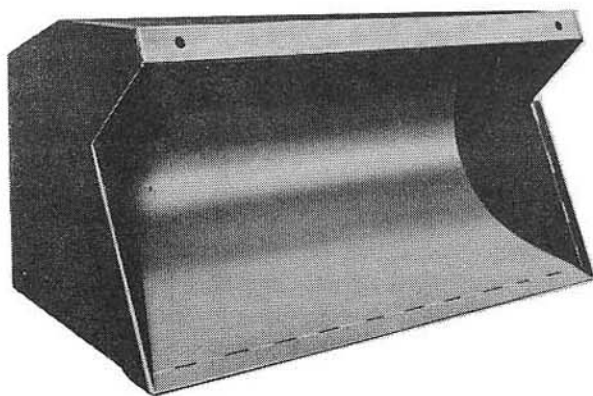

19-125 Standard Material Bucket: 15 Cu. Ft. ⬆

Cutting Width: 61-1/2 inches
Inside Height: 25-1/2 inches
Depth: 23-1/4 inches
Weight: 360 pounds (approximate)

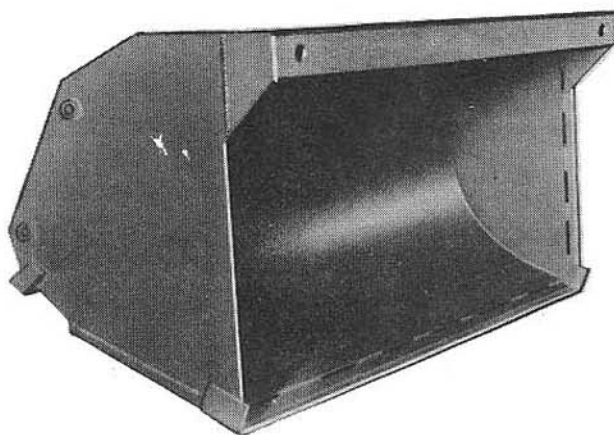

19-252 Stockpile Bucket: 16 Cu. Ft. ⬆

Cutting Width: 41-1/2 inches
Inside Height: 29-1/4 inches
Depth: 32 inches
Weight: 350 pounds (approximate)

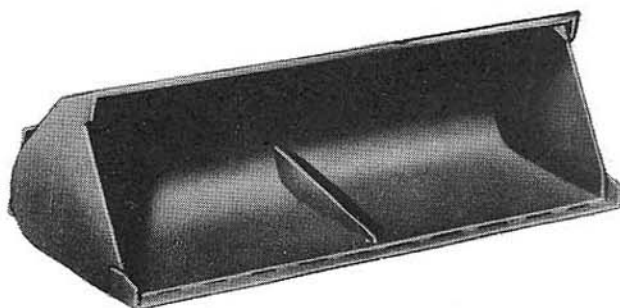

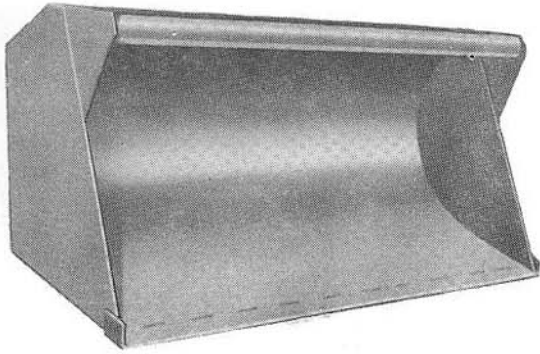

19-333 Material Bucket: 16 Cu. Ft.

Cutting Width: 67-1/2 inches
Inside Height: 26-3/4 inches
Depth: 21 inches
Weight: 410 pounds (approximate)

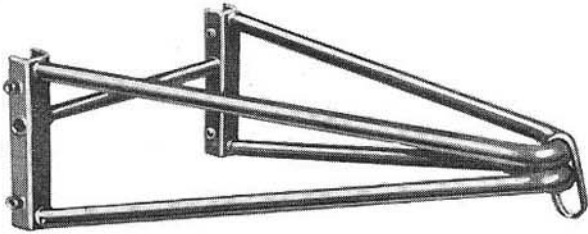

19-136 Crane: The crane attachment provides a 15 foot 10 inch lift height and a 70-1/2 inch reach with a lift capacity of 980 pounds on the Ford 3400 Tractor. It is fast and easy to attach or detach and will perform any number of lifting jobs.

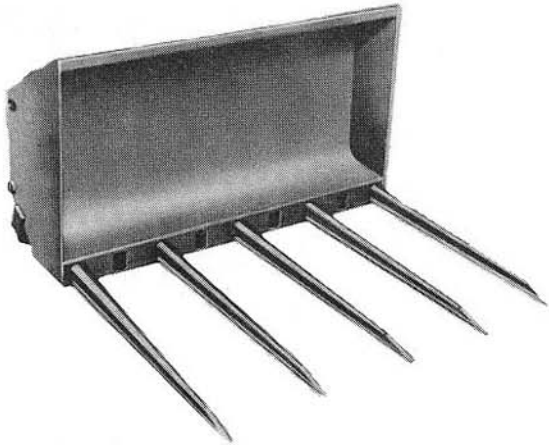

19-214 Material Fork: The material fork can be used with five to nine replaceable tines, depending on the consistency of material being handled.

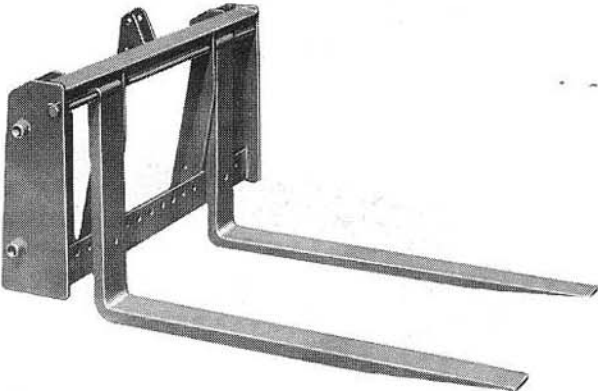

19-283 Fork Lift Attachment: This attachment is designed for lifting pallets, logs, bales, and other similar bulky materials. Its maximum lift capacity is 1550 pounds on the Ford 3400 Tractor. The tines are 42 inches long and are adjustable from a width of 8-3/4 inches to 37 inches. The maximum lift height is 9 feet 8 inches with the tines level. The fork lift attachment will also fit on the standard Category I tractor three-point linkage.

19-194 Six-Foot Dozer Blade and 19-195 Seven-Foot Dozer Blade: A six-foot and seven-foot dozer blade is available for use with the Series 730 Loader. The blade cutting edge is reversible, providing two usable cutting edges.

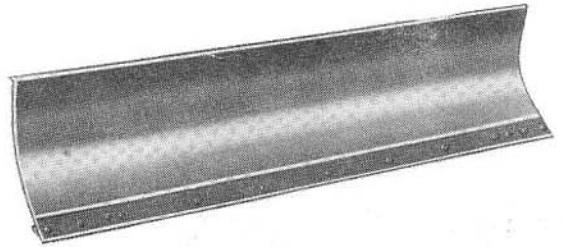

19-137 Dozer Blade Angle Adapter: This adapter is used for attaching a dozer blade to the loader lift arms. The adapter permits the blade to be angled and pitched.

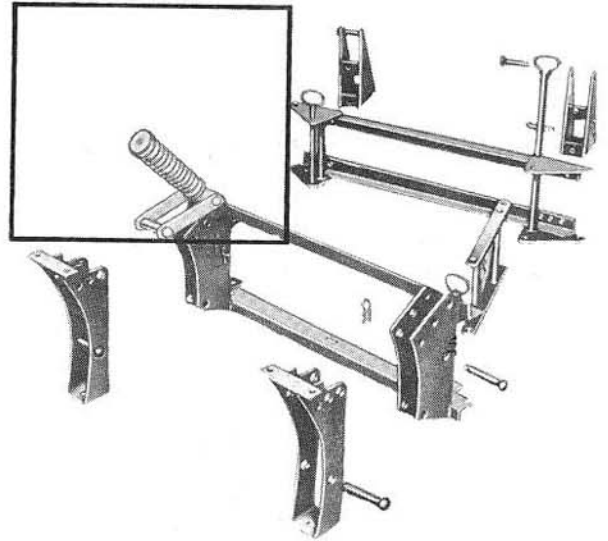

19-138 Spring Release Kit: This kit is used on the 19-137 Blade Adapter to absorb shock and to provide a release mechanism for the dozer blade.

19-141 Dozer Blade Mounting Brackets: This bracket provides a method for attaching a dozer blade to the loader lift arms in the straight position only.

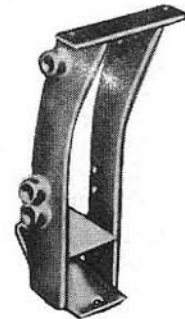

Bucket Level Indicator, Part No. 290415: The installation of a bucket level indicator assists the operator in determining if the bucket is level.

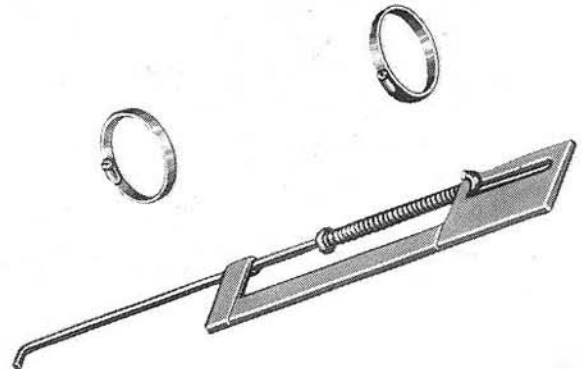

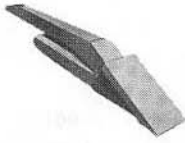

Bucket Tooth, Part No. 114541: The installation of bucket teeth increases digging action in hard ground. Six or nine teeth may be installed, depending on the size of the bucket.

ATTACHMENT INSTALLATION

The bucket or other attachment is easily installed on the loader as follows:

1. Start the tractor and operate the engine at 1200–1500 rpm.

2. Position the bucket cylinder rods so the square face of the rod end is in the up position, as shown in Figure 3. The longer portion of the cylinder rod end is a bucket stop when the bucket cylinder is retracted.

3. Extend the bucket cylinder rods, as required, to allow attachment of the bucket as shown in Figure 3. Attach the bucket using four 1" x 6" pins, as shown at (1). Retain the pins in position by using four hardened bolts, one through each hole in the bucket bushing and the hole in the pin, as shown at (2). Secure the retaining bolts, using four lock nuts, as illustrated at (3).

LUBRICATION

The loader is lubricated through ten lubrication fittings. Figure 4 shows the fittings on one side of the loader; fittings will be found in the same locations on the other side of the loader.

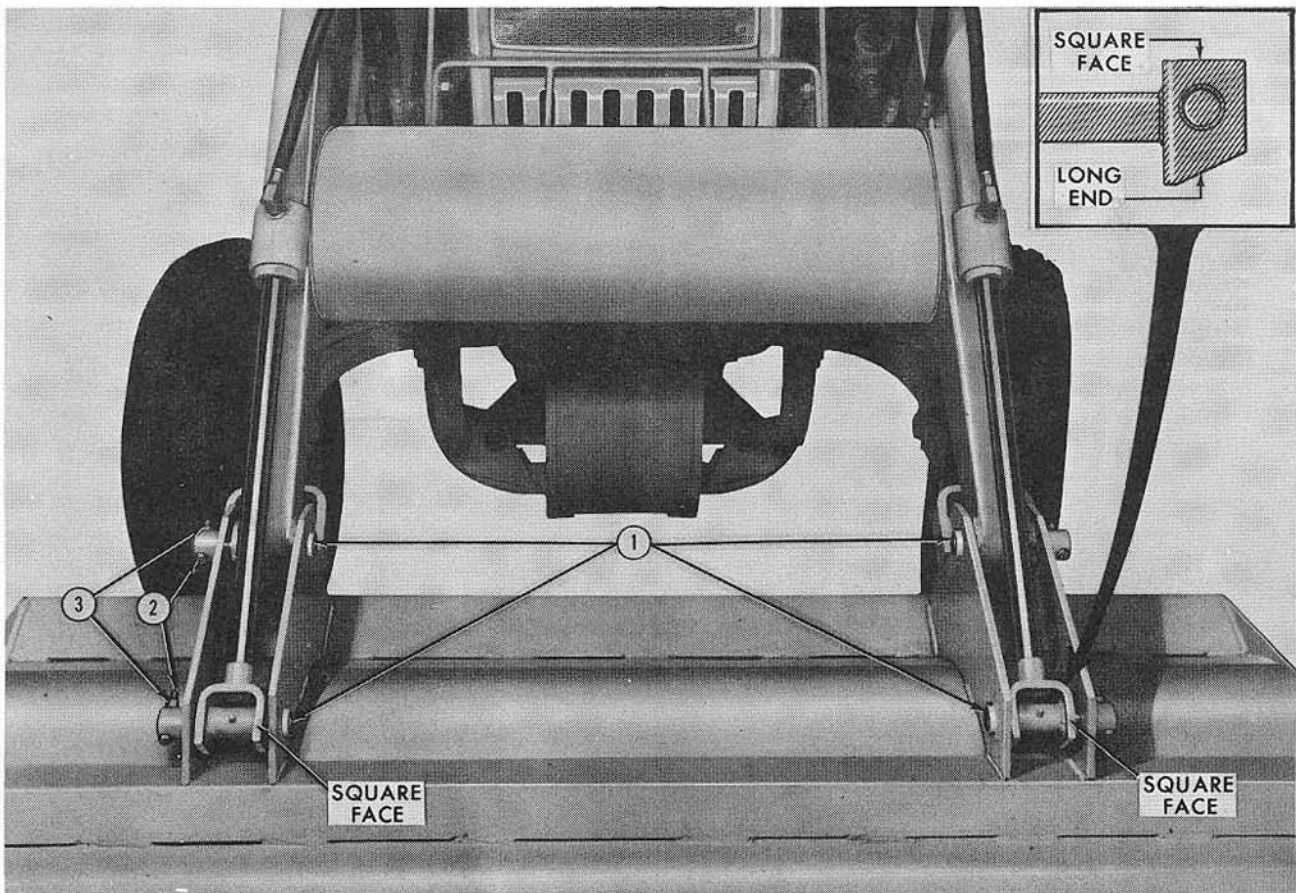

Figure 3
Bucket Installation

Lubricate the loader after every eight hours of operation. Use a sufficient amount of new grease to force out the old dirt-encrusted grease.

LOADER HYDRAULIC SYSTEM MAINTENANCE

Regular attention to maintenance of the loader hydraulic system will pay dividends in maximum loader efficiency and longer life. Always:

- Use Ford Specification M-2C48-A Hydraulic Oil. Foaming oil is caused by using oil of different specification.
- Repair hydraulic oil leaks promptly to avoid loss of oil and damage to the system.

CAUTION: *When leakage is observed, shut off the tractor engine and relieve all hydraulic pressure by actuating the control levers before attempting to repair the leak. Do not repair or tighten any hydraulic connection while the system is under pressure.*



- Operate the loader for 15 minutes to bleed air from the system after changing the hydraulic oil or filter.
- Replace hoses immediately if they are severely damaged by a cut or scrape, extended at the fittings, or leaking.
- Check the loader oil level daily.

An Inlet Hose Reinforcement Spring, Part No. 290991, is available from your Ford Tractor-Equipment Dealer. One spring installed in each inlet tube hose will reduce the possibility of hose collapse, which may result during extremely cold weather operation.

If the lift cylinder hoses are disconnected for maintenance or hose replacement, be sure the hoses are properly reinstalled as follows:

Non-Self-Leveling Loaders: Be sure the hose assembly (4), Figure 4, from the piston end of the right-hand lift cylinder, is connected to the lower hydraulic tube (2), and the hose assembly from the rod end of the cylinder (3), is connected to the upper hydraulic tube (1).

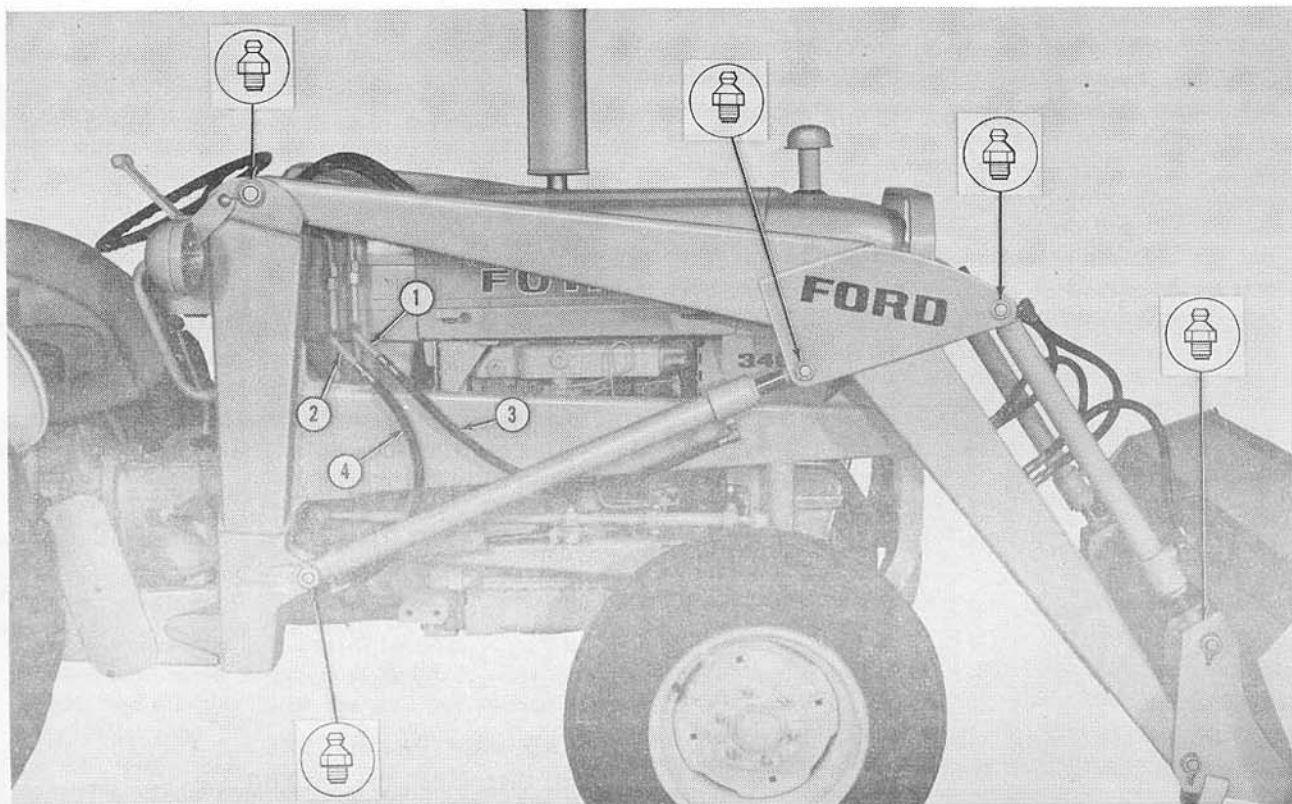

Figure 4

Lubrication Fitting Locations and Lift Cylinder Hose Installation

Self-Leveling Loaders: Be sure the hose assembly (10), Figure 5, from the piston end of the right-hand lift cylinder, is connected to the lower hydraulic tube (9), and the hose assembly (11), from the rod end of the cylinder is connected to the adapter (7), installed in the tee fitting (6). Verify that the "Free-Flow" arrow on the check valve assembly (3), is pointing toward the front of the tractor; also that the O-ring and connector (4) and (5), are installed as shown; and the tubes (1) and (8), are connected to the tee fittings (2) and (6), as shown. Correct if necessary. Tighten all fittings securely.

Loader hydraulic system general maintenance should be performed at the prescribed intervals outlined below.

IMPORTANT: *The service intervals for the maintenance operations that follow are based on normal operating conditions. Your particular operation may require servicing the components more often.*

CHECKING HYDRAULIC OIL LEVEL

Check the oil level in the loader hydraulic system daily. Maintain the oil level 8 inches from the top of the filler plug opening, as shown in Figure 6.

IMPORTANT: *Prior to checking the hydraulic oil level, all loader cylinders must be retracted, with the bucket rolled back and resting on the ground. If a backhoe is installed, the backhoe cylinders must be in the "Park" position. In the "Park" position, the stabilizers are resting on the ground; the bucket and crowd cylinders are retracted, and the lift cylinder is extended until the bucket teeth rest on the ground.*

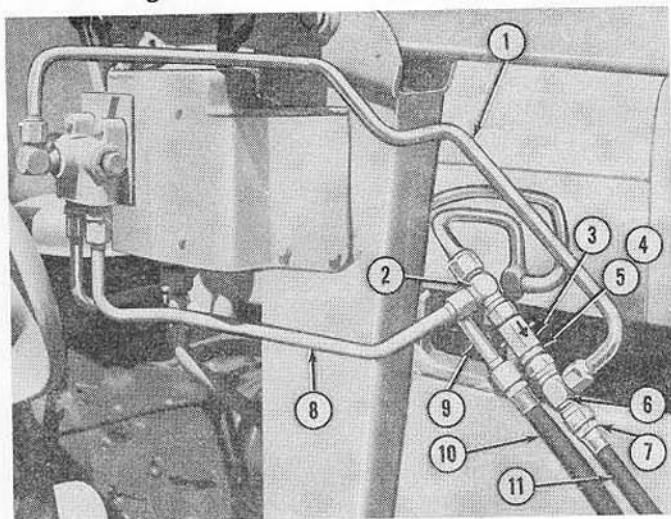

Figure 5
Self-Leveling Loader –
Right-Hand Lift Cylinder Hoses Installed

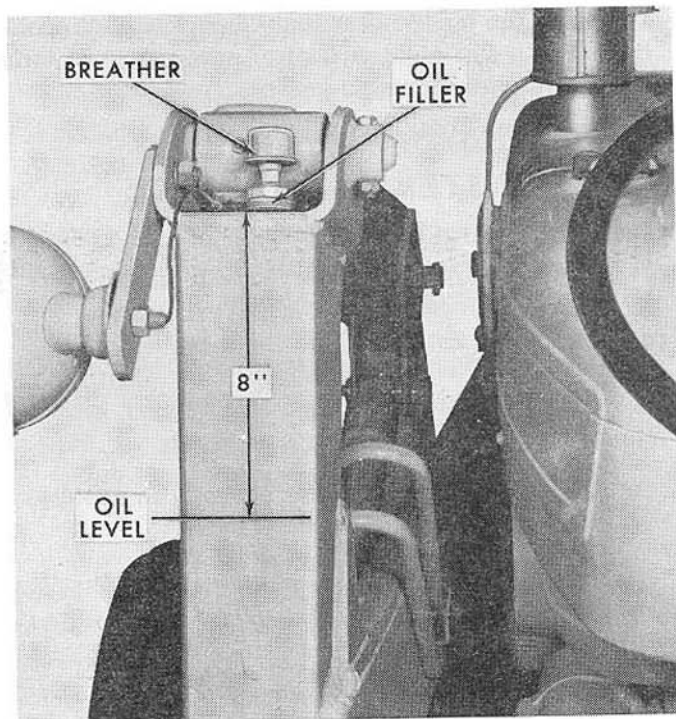

Figure 6
Oil Level and Breather Location

CLEANING OIL BREATHER CAP

The hydraulic oil breather should be checked every 50 hours and replaced at every filter change and at every hydraulic oil change.

1. Remove the breather assembly and oil filler plug, Figure 6.
2. Inspect the breather assembly for accumulation of dirt and dust on the filter element.
3. If necessary, install a new breather assembly in the oil filler plug and install the oil filler plug in the filler plug opening.

IMPORTANT: *Washing the breather assembly in water or solvent will result in damage to the filter element. Replace the breather assembly when dirt or dust accumulates on the filter element.*

DRAINING HYDRAULIC OIL AND CHANGING OIL FILTER

The hydraulic oil filter should be changed after the first 50 hours of operation and every 300 hours there-

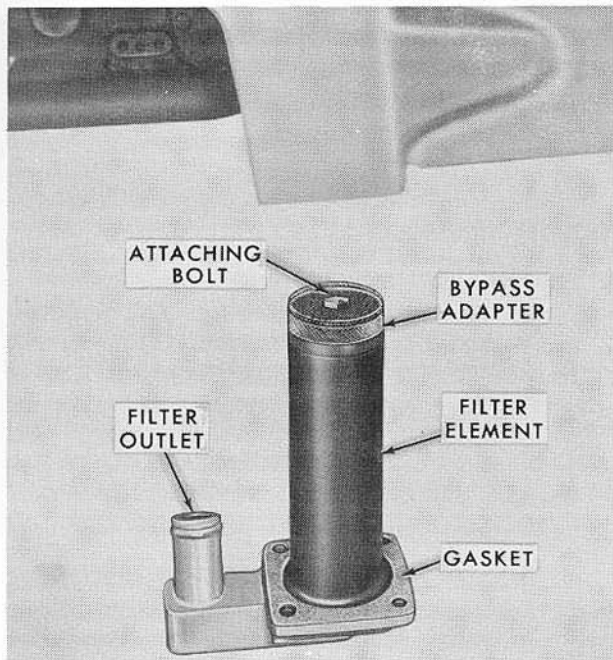

Figure 7
Hydraulic Oil Filter

after, as well as at every hydraulic oil change. The hydraulic system oil should be changed every 600 hours or annually, whichever occurs first.

1. Operate the tractor engine at 1200–1500 rpm and actuate the loader control levers until the hydraulic oil has reached normal operating temperature.
2. Stop the tractor engine. Remove external dirt from under the left loader frame post and filter adapter area to prevent foreign material from entering the drained oil, if it is to be reused in the loader.
3. Place a clean drain pan under the post. Using an Allen wrench, remove the drain plug from the oil filter retainer and allow the oil to drain from the reservoir. Removing the drain plug will allow oil to pass through the filter as it drains. The oil will drain faster if the oil filler plug, Figure 6, is removed. After the oil has drained, remove the pan and oil from under the unit and reinstall the oil filler plug.

NOTE: Take care to keep the oil clean if it is to be reused in the loader. Dirt and contaminants will damage the hydraulic system.

4. Loosen the lower clamp on the suction tube connecting hose and remove the hose from the filter outlet.
5. Remove the filter retainer attaching bolts from the bottom of the post and remove the filter assembly.
6. Remove the filter attaching bolt and separate the bypass adapter from the oil filter element. Discard the oil filter element and gasket, Figure 7. Fine contaminants imbedded in the filter cannot be washed away and a partially plugged filter will restrict oil flow.
7. Flush the interior of the loader post housing the filter with clean flushing oil to remove any foreign material that may have accumulated in the casting rib area.
8. Clean the filter retainer and bypass adapter with a suitable solvent. Install a new gasket and a new filter element on the retainer and secure with the bypass adapter and attaching bolt. Tighten the bolt 1/2 turn after the filter stops turning freely.

IMPORTANT: Do not overtighten the attaching bolt. Overtightening may crush and ruin the filter.

9. Install the filter assembly in the loader lift post. Secure with the four attaching bolts.

IMPORTANT: Be sure the gasket is properly positioned on the filter retainer to prevent hydraulic leakage.

10. Attach the suction tube connecting hose to the filter outlet and secure with the hose clamp.
11. Fill the hydraulic system with Ford Specification M-2C48-A Hydraulic Oil until the oil level is 8 inches from the top of the filler plug opening, as shown in Figure 6. System capacity is approximately 10-1/2 U.S. gallons.
12. Start the tractor engine and run it at 1200–1500 rpm. Actuate the loader control levers (no load in the bucket) for approximately 15 minutes to bleed air from the system.
13. Relieve hydraulic pressure by actuating the loader control levers with the engine off. Recheck the oil level with all loader cylinders retracted (see "CHECKING HYDRAULIC OIL LEVEL"). Add oil through the oil filler plug opening as required.

LOADER REMOVAL AND STORAGE

Always store the loader in a clean, dry place. Coat the exposed parts of the control valve spools and cylinder rods with a rust preventive.

The loader is removed from the tractor as follows:

1. Remove the drain plug from the bottom of the left loader frame lift post and allow the oil to drain. Reinstall the drain plug.
2. Disconnect the hydraulic lines from the pump, as shown in Figure 8 at (1) and (3).
3. Cap the ends of the hydraulic lines and the pump openings to prevent foreign material from entering the system.
4. Disconnect the headlamp wiring harness lead at each headlamp.
5. Remove the bucket if desired. The loader can be removed without removing the bucket.
6. Attach a suitable chain hoist to the loader frame as shown in Figure 9.



CAUTION: Make sure the lift chain is not defective and take the time to make a secure hookup.

7. Remove the nuts and lock washers from the fender bolts, or adapter plate bolts securing the loader frame to the rear axle. Remove the two 1" x 4-1/2" bolts and lock nuts that attach the loader frame to the pump mounting plate assembly.

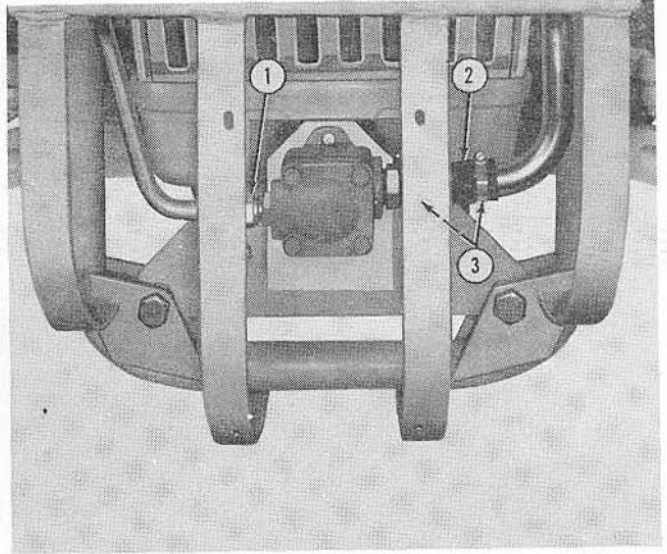

Figure 8
Hydraulic Pump Installed

8. Raise the loader frame to provide clearance between the tractor front axle and steering linkage and the loader frame. Manually roll the tractor rearward to clear the loader, and lower the loader.

IMPORTANT: Do not start the tractor engine or severe pump damage will result.

9. Remove the hydraulic pump and the pump mounting plate assembly from the front of the tractor.
10. Remove the hydraulic pump drive shaft.
11. Install the tractor fenders with the lock washers and nuts removed in Step 7.
12. Remove the headlamps from the loader frame and install them on the tractor in their original position. Remove the loader headlamp harness from the tractor headlamp switch, and reinstall the original headlamp wire of the tractor wiring harness on the switch.

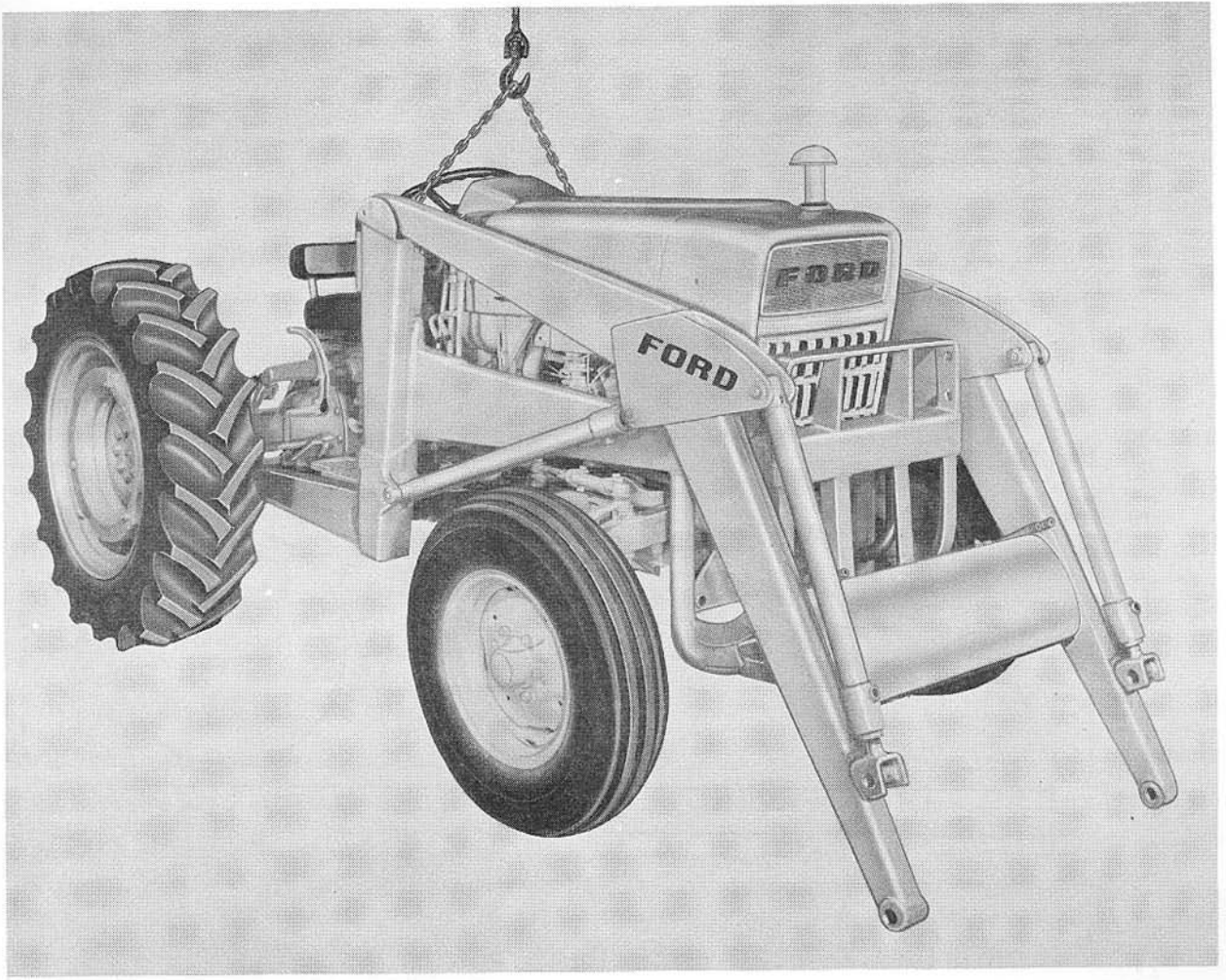
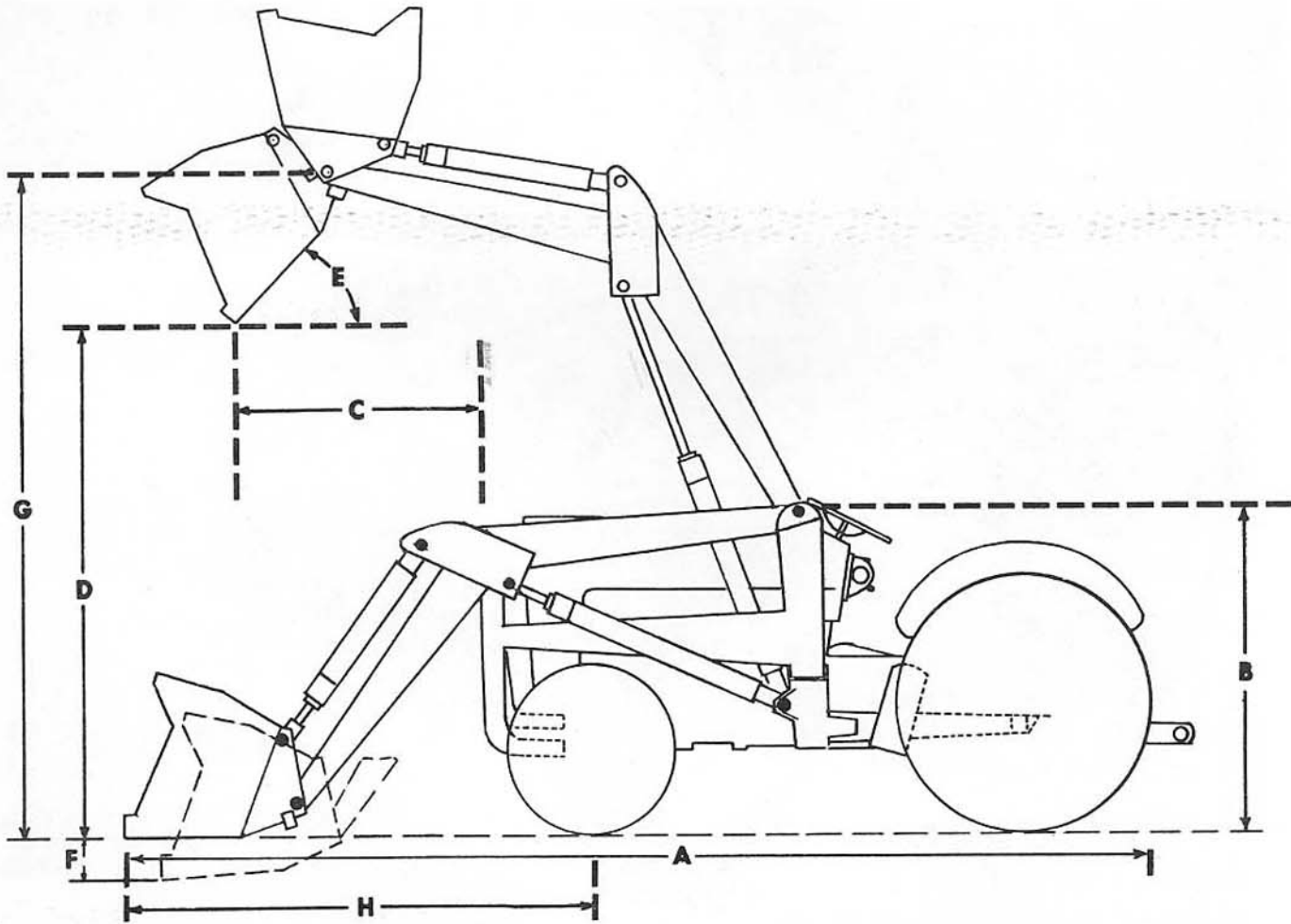

Figure 9
Removing or Installing Loader with a Chain Sling



A Overall Length	14 feet
B Height — to top of loader post	4 feet 10 inches
C Reach — at maximum height with bucket dumped at 42 degrees	19-1/2 inches *
D Dump Clearance Height — bucket dumped at 42 degrees	8 feet 7 inches *
E Dump Angle — maximum	42 degrees *
F Digging Depth — level bucket	4 inches *
G Lift Height — bucket pivot	10 feet 5 inches *
H Bucket Tip to Front Axle	62-3/8 inches *
Approximate Shipping Weight.....	1000 pounds

* Figures shown correspond to the specification definitions of the Industrial Equipment Manufacturers Council (I.E.M.C.).

NOTE: The above dimensions are based on a Ford 3400 Tractor equipped with 14.9–24 rear tires, 7.50–16 front tires, and a 19-333 Material Bucket.

SPECIFICATIONS

PERFORMANCE

	<u>19-512, 19-513, and 19-516</u>	<u>19-427</u>
Breakaway Capacity	3385 pounds *	3100 pounds *
Lift Capacity – Full Height	2200 pounds *	1625 pounds *
Speed of Lift (No Load)		
With 19-415 Pump	3.6 seconds *	3.6 seconds
With 19-414 Pump	2.6 seconds *	2.6 seconds
Speed of Drop (No Load)		
With 19-415 Pump	1.8 seconds *	1.8 seconds
With 19-414 Pump	1.3 seconds *	1.3 seconds

BUCKET OPERATION

Bucket Dump		
With 19-415 Pump	1.7 seconds *	1.7 seconds
With 19-414 Pump	1.2 seconds *	1.2 seconds
Bucket Dump Angle at Full Lift	42 degrees *	42 degrees *
Bucket Rollback at Ground Level	21 degrees *	21 degrees *

HYDRAULIC SYSTEM

Loader Relief Valve Pressure Setting	
19-512, 19-513, and 19-516	2200 psi ± 50 psi @ 1700 rpm
19-427	1900 psi ± 50 psi @ 1700 rpm
Backhoe Relief Valve Pressure Setting	2200 psi ± 50 psi @ 1700 rpm
Oil Capacity	10-1/2 gallons
	Main frame is the reservoir with filler boss and breather on top of left frame post.
Oil Specification	Ford Specification M-2C48-A
Oil Filter	Pump Inlet Line – Throw-Away Type

* Figures shown correspond to the specification definitions of the Industrial Equipment Manufacturers Council. (I.E.M.C.)

SPECIFICATIONS

RESERVOIR

Type Main Frame Structure
Location Horizontal members of frame and left frame post

PUMP

Type Vane
Capacity (19-512, 19-513, 19-516)
19-414 19.4 gpm at 2200 psi – 2100 rpm – 180° F.
19-415 14.0 gpm at 2200 psi – 2100 rpm – 180° F.
Capacity (19-427)
19-414 19.8 gpm at 1900 psi – 2100 rpm – 180° F.
19-415 14.2 gpm at 1900 psi – 2100 rpm – 180° F.
Mounting Direct to front mounting bracket
Drive Splined drive shaft with flexible coupling

CONTROL VALVE

Type (19-512)..... Two-spool, open center, with 3-position spools to control lift cylinders and 3-position spools to control bucket cylinders. Spring-loaded spools for self-centering in neutral position. Anti-cavitation check for bucket cylinders.
Type (19-513)..... Two-spool, 4-position lift with float position and 3-position bucket. Spring-loaded spools for self-centering in neutral position. Anti-cavitation check for bucket cylinders.
Type (19-427)..... Same as 19-512 except lift spool controls single-acting lift cylinders.
Type (19-516)..... Three-spool, 4-position lift including compensating lift and float position, and 3-position bucket. Spring-loaded spools for self-centering in neutral position. Anti-cavitation check for lift and bucket cylinders. Attached selector valve allows compensating action of valve to be used or bypassed.

SPECIFICATIONS

BUCKET CYLINDERS

Type	Double-Acting
Extended Length	51-3/8 inches
Retracted Length	31-5/16 inches
Stroke	20-1/16 inches
Piston Diameter	2 inches
Rod Diameter	1-1/4 inches

LIFT CYLINDERS

Type (19-512, 19-513, and 19-516)	Double-Acting
Type (19-427)	Single-Acting
Number (19-512, 19-513, and 19-516)	2 Double-Acting
Number (19-427)	2 Single-Acting
Extended Length	76 inches
Retracted Length	42-11/16 inches
Stroke	33-21/64 inches
Piston Diameter	2 inches
Rod Diameter (19-512, 19-513, and 19-516)	1-1/2 inches
Rod Diameter (19-427)	2 inches

"Ford Motor Company, whose policy is one of continuous improvement, reserves the right to make changes in design and specifications at any time without notice and without obligation to modify units previously built."