

FORD TRACTOR

601 AND 801

SERIES



OWNER'S

MANUAL

Prepared by
**TRACTOR AND IMPLEMENT DIVISION
FORD MOTOR COMPANY**

Tractor Service Policy

AUTHORIZED

TRACTOR

AND
IMPLEMENT DEALER'S
SERVICE POLICY

OWNER'S NAME _____

MAILING ADDRESS _____

CITY _____ STATE _____

TRACTOR MODEL _____

SERIAL NUMBER _____

DELIVERY DATE _____

ISSUED BY: _____

FORD TRACTOR AND IMPLEMENT DEALER _____

CITY _____ STATE _____

This Tractor Service Policy is valid only when issued with a new Ford Tractor or a new Fordson Major Diesel Tractor that is sold and delivered to the above-named owner by the undersigned Ford Tractor and Implement Dealer, and if signed by said owner at the time of issuance.

DEALER'S SIGNATURE _____

OWNER'S SIGNATURE _____

At the time of delivery of your new tractor, the Ford Tractor and Implement Dealer presented to you a copy of the Service Policy shown above. This policy certifies that your new Ford Tractor has been properly inspected and prepared for delivery by the dealer.

The policy should be presented to the dealer whenever you request any service which is authorized on it. We recommend, therefore, that you keep the policy in a safe place for ready reference at all times.

FORD TRACTOR

*All Purpose and
Special Utility Models*

SERIES 601 AND 801

OWNER'S MANUAL

Copyright 1957

Ford Motor Company

Dearborn, Michigan

All Rights Reserved

"Reproduced under license agreement
with Ford Motor Company."
License # 5001 3-1-94

Prepared by

**TRACTOR AND IMPLEMENT DIVISION
FORD MOTOR COMPANY
BIRMINGHAM, MICHIGAN**

STANDARD AND OPTIONAL EQUIPMENT CHART

Model	STANDARD EQUIPMENT										OPTIONAL EQUIPMENT							
	4-Speed Trans.	5-Speed Trans.	Proof-Meter	Temp. Gauge	Hyd. System	Three Point Linkage	Live PTO	PTO	Swinging Draw-bar	Lights	Rest-O-Ride Seat	Tools and Tool Box	4-Speed Trans.	Power Steer.	Power Adj. Wheels	PTO	Auxiliary Trans.	
SPECIAL UTILITY MODELS	621	X							*X					X	X	X	X	X
	631	X			X									X	X	X	X	X
	821		X						*X				X	X	X	X	**X	
	641	X		X	X	X		X	X	X		X		X	X			X
	651		X	X	X	X		X	X	X		X		X	X			
	661		X	X	X	X	X	X	X	X		X		X	X			
	851		X	X	X	X		X	X	X	X	X		X	X			
	861		X	X	X	X	X	X	X	X	X	X		X	X			
841	X		X	X	X		X	X	X		X		X	X			X	
ALL PURPOSE MODELS																		

*Fixed drawbar.

**Optional when Model 821 is equipped with a 4-Speed Transmission.

FOREWORD

We wish to congratulate you on your choice of the new Ford Tractor. We are happy to have you as a customer and are confident that you will receive unequalled performance from your Ford Tractor.

This manual has been prepared to acquaint you with the many features of your new Ford Tractor. Due to the selection of engines, transmissions, clutches and axles available with the new Ford Tractors, most of the information presented here is general and applies to both Series 601 and 801 tractors.

The 601 and 801 Series includes both the "All Purpose" and "Special Utility" Tractors. Refer to the Standard and Optional Equipment Chart on Page 2. Read this manual carefully at your first opportunity and keep it in a convenient location for later reference. You will be particularly interested in the "break-in" instructions starting on Page 14, and the maintenance instructions starting on Page 29.

If, at any time, you have a question or problem concerning your new tractor, remember that your Ford Tractor and Implement Dealer is best qualified and equipped to serve your needs. With the proper treatment and service, your Ford Tractor should provide you with a long life of profitable and dependable service.



TRACTOR AND IMPLEMENT DIVISION
FORD MOTOR COMPANY
SERVICE DEPARTMENT

TRACTOR MODEL AND SERIAL NUMBER

All Purpose Ford Tractors: These tractors are identified by the model numbers 641, 651, 661, 841, 851 and 861.

Special Utility Ford Tractors: These tractors are identified by the model numbers 621, 631 and 821 and have the same features as the other models in the corresponding series except those features which are not necessary to special utility work. Model numbers for both the ALL PURPOSE and SPECIAL UTILITY FORD TRACTORS identify the type of tractor, engine, transmission, clutch and axle.

When ordering parts or requesting information from your Ford Tractor and Implement Dealer, always specify the Model and Serial Number of your Ford Tractor.

The Model and Serial Number is located on the left front side of the transmission housing and should be recorded immediately in the space provided below.

MODEL

SERIAL NO.

CONTROLS AND INSTRUMENTS

The controls on your new Ford Tractor are designed to help you do more work with the greatest possible convenience and comfort. All are within easy reach and are simple to operate.

The well-grouped instruments tell you, at a glance, whether the engine is operating efficiently and warn you of the possibility of trouble before it becomes serious.

Before attempting to start or operate your new tractor, familiarize yourself with the location and function of all controls and instruments



*Know your controls and instruments
to assure Safe Operation.*

CONTROLS AND INSTRUMENTS

TRACTOR SEAT

Take your place in the tractor seat. If the seat is not in the most comfortable operating position, it may be moved forward or rearward as desired. The seat pan may be tilted back, permitting the operator to stand, or to protect it from dew and rain. Series 801 All Purpose tractors are equipped with a Rest-O-Ride seat which may be adjusted to accommodate the weight of individual operators.

LIGHT SWITCH

The tractor lights are operated by means of a switch on the lower right side of the instrument panel, just below the side panel. Pull the switch out to turn the lights on.

IGNITION SWITCH

The ignition switch is located on the lower left side of the instrument panel, just below the side panel. Turn the key clockwise to turn the ignition on, and counter-clockwise to turn it off.

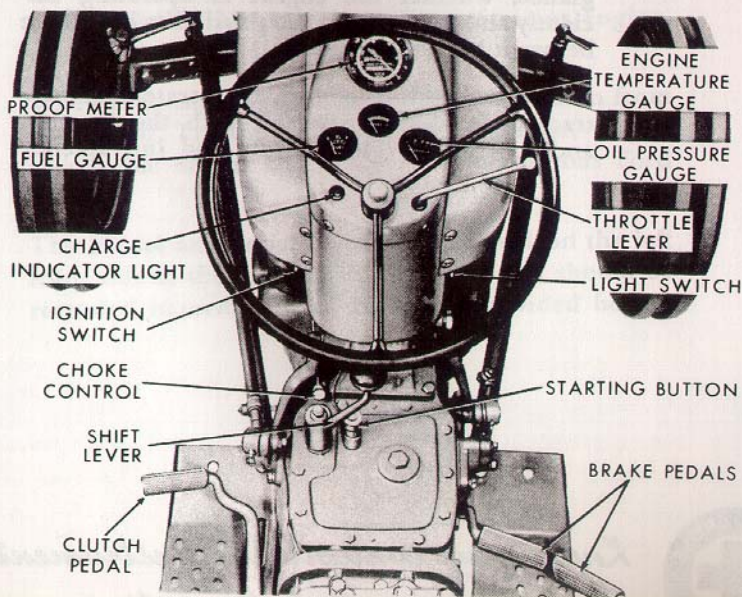

Figure 1
Controls and Instruments

CHOKE CONTROL

Initial starting may require the use of the choke control located to the left of the starter button. After the engine has been sufficiently warmed up, the choke control should be returned to its normal position as soon as possible.

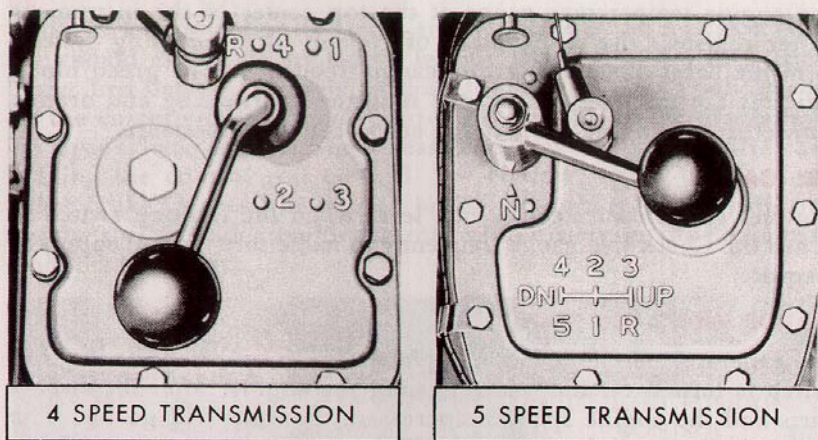

Figure 2
Gear Shift Positions

GEAR SHIFT LEVER

The gear shift lever is located directly in front of the tractor seat. For your convenience, a diagram of the shift pattern is provided on the transmission cover. The shift positions for both four and five speed transmissions are shown in Figure 2.

STARTER BUTTON

The Ford Tractor is equipped with a safety type starter button, located on top of the transmission housing within easy reach of the operator. The safety feature incorporated in the starter makes it impossible to depress the starter button without first placing the gear shift lever in the neutral position.

THROTTLE CONTROL

The hand operated throttle control is located at the right side of the steering wheel column. Pull the lever down to increase the engine speed.

OIL PRESSURE GAUGE

The engine oil pressure gauge indicates the oil pressure through oil passages, but does not show the amount of oil in the crankcase. Oil

in the crankcase can become dangerously low and still show pressure on the gauge. Check the pressure gauge periodically when operating your tractor to be sure that the lubrication system is operating satisfactorily.

TEMPERATURE GAUGE

The engine temperature gauge at the top center of the instrument cluster registers the temperature of coolant in the cooling system. Form the habit of checking this gauge frequently. The green block indicates normal temperature, red indicates overheating and orange shows that the engine is operating at too cold a temperature.

FUEL GAUGE

The fuel gauge indicates the fuel level when the ignition switch is turned on. Check this gauge frequently to make sure the fuel supply is adequate.

CHARGE INDICATOR LIGHT

The generator charge indicator light will flash on when the ignition switch is turned on and while starting the engine. After the engine starts and the engine speed is increased, the light will go out. The charge indicator light flashes on if the generator is not supplying current to the battery.

CLUTCH PEDAL

The foot operated clutch pedal, located on the left side of the transmission housing, must be depressed to disengage the clutch. For information on the live PTO clutch (Tractor Models 661 and 861), see the section on power take-off operation, page 20.

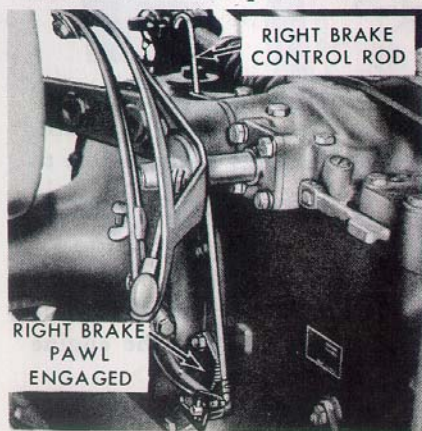

Figure 3

Brake Pawl Engaged

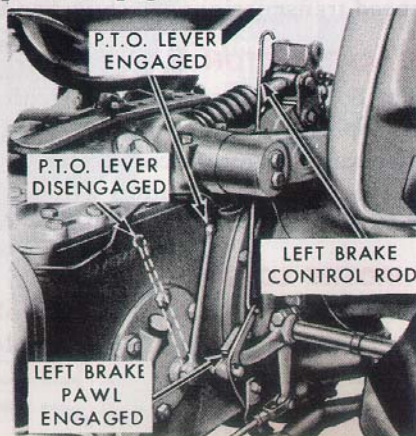

Figure 4

Power Take-Off Lever Engaged

BRAKE PEDALS

Foot operated brake pedals are provided on the right side of the transmission housing. To stop the tractor, depress both pedals simultaneously. Apply the right brake when making short right turns, and the left brake when turning left.

BRAKE PEDAL LOCKS

Brake locks, located on the right and left sides of the rear axle housing should always be set before leaving the tractor. To lock either brake, first depress the right or the left brake pedal and pull upward on the corresponding brake control rod to engage the brake pawl. To insure lock engagement, release the brake pedal slightly while holding the control rod upward. See Figures 3 and 4. To release either brake, depress the desired brake pedal sharply. This will permit the spring loaded brake control rod to disengage the brake pawl from the brake lock.

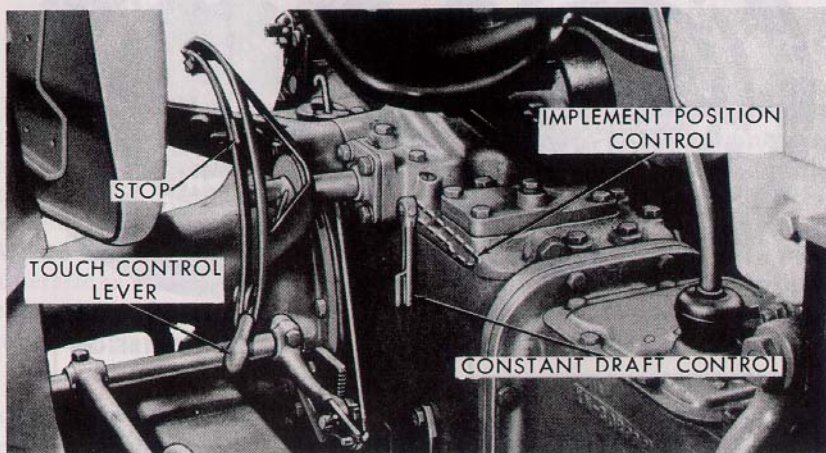

Figure 5
Hydraulic Control Levers

POWER TAKE-OFF LEVER

The power take-off lever is located on the left side of the center housing. The power take-off is engaged when the lever is in the rear position (see Figure 4), and disengaged when the lever is forward. Always depress the clutch pedal when engaging or disengaging the power take-off while the tractor engine is running.

HYDRAULIC TOUCH CONTROL LEVER

The touch control lever, which controls the hydraulic system, is the large lever to the right of the tractor seat. To raise the lift arms, raise the lever to the top position. To lower the lift arms, push the lever to the lower position.

SELECTOR LEVER

The selector lever under the tractor seat changes the hydraulic system from constant draft to implement position control. Place the lever in the "Down" position for Constant Draft Control, and in the "Up" or horizontal position for Implement Position Control.

FUEL SHUT-OFF VALVE

The fuel shut-off valve is located at the center underside of the fuel tank (see Figure 30). Turn the valve to the right (clockwise) to shut off the fuel supply to the carburetor. Turn the valve (counterclockwise) to the stop to allow the fuel to flow.

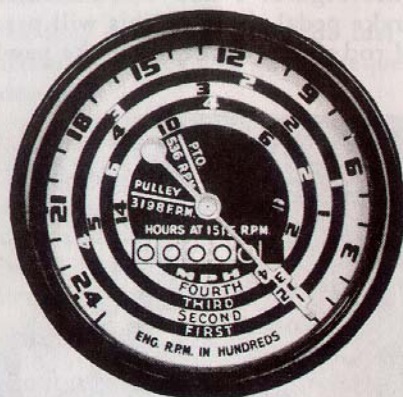

4 SPEED TRANSMISSION

Figure 6
Proof-Meter
Model 641, 841

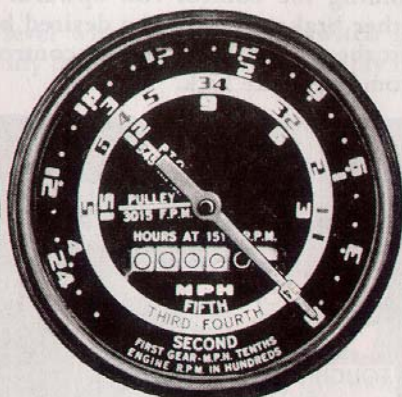

5 SPEED TRANSMISSION

Figure 7
Proof-Meter
Models 651, 661, 851, 861

PROOF-METER

The Ford Tractor Proof-Meter, conveniently located at the top center of the instrument panel, is actually five instruments in one. At a quick glance, it tells you the engine speed, tractor ground speed, P.T.O. speed, belt pulley F.P.M. and hours worked. The separate functions of the Proof-Meter are described in the following paragraphs and illustrations.

Engine Speed: Engine revolutions per minute (R.P.M.) are shown in hundreds on the outer band of the Proof-Meter as the long needle moves from 0 to 24. Knowing the correct engine speed is helpful in checking correct oil pressure and maintaining the proper engine idle speed.

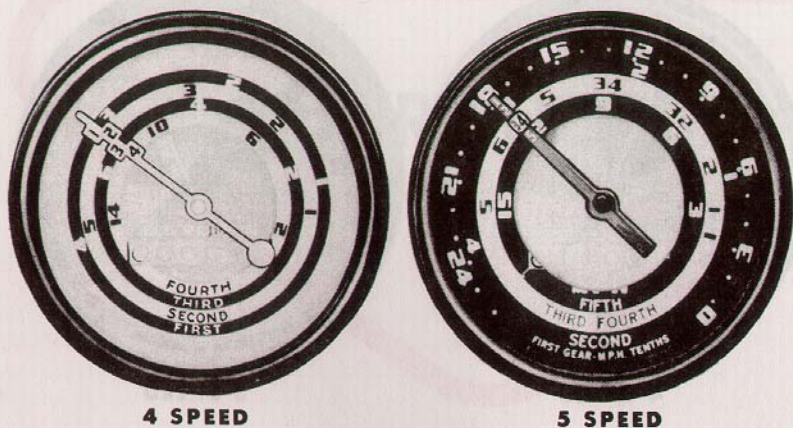

Figure 8
Tractor Ground Speed (M.P.H.)

Tractor Ground Speed: The ground speed (M.P.H.) on Model 641 tractors with four speed transmissions is indicated by the long needle, and is read in the band directly under the gear number on the needle as shown in Figure 8. On tractors with five speed transmissions, the speed is read in the same manner except in third and fourth gear, where the respective speeds are indicated in different colors. In field operations such as mowing, planting, spraying and combining, proper tractor speed is very important. With the Proof-Meter, you can be sure that your tractor ground speed is right.

P.T.O. Speed: The American Society of Agricultural Engineers (A.S.A.E.) standard for power take-off speed is 540 revolutions per minute as shown in Figure 9. Most power take-off implements will operate at maximum efficiency when the Proof-Meter needle is held at this speed. For further information on the Power Take-Off, refer to Page 20 of this manual.

Belt Pulley Speed: The performance of most stationary farm implements is better and safer when they are operated at the correct belt pulley speed. The A.S.A.E. has standardized the belt speeds on farm tractors at 3000 to 3200 feet per minute. With the standard 9-inch belt pulley on the Model 641, Ford Tractor (sold as extra equipment), standard belt speed is 3199 feet per minute at 2000 engine R.P.M. as shown on the four speed Proof-Meter. (See Figure 10). On tractors with five speed transmissions, the standard belt speed is 3013 feet per minute as 2200 engine R.P.M. Additional information on operating the belt pulley is included in the section on OPERATION, Page 21 of this manual.

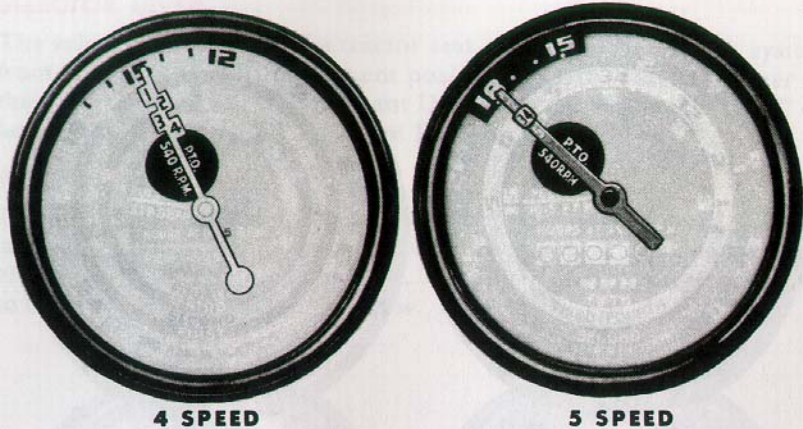

Figure 9
Power Take-Off Speed

Engine Hours: The hour meter portion of the Proof-Meter represents the hours your tractor engine has “worked,” based on an average engine speed of 1515 revolutions per minute. Engine speeds below 1515 revolutions accumulate hours more slowly than clock hours, and those above 1515 R.P.M. register faster than clock hours. Use this feature of the Proof-Meter to determine when service and maintenance are necessary. It will help you cut operating costs and prolong the life of your new tractor.

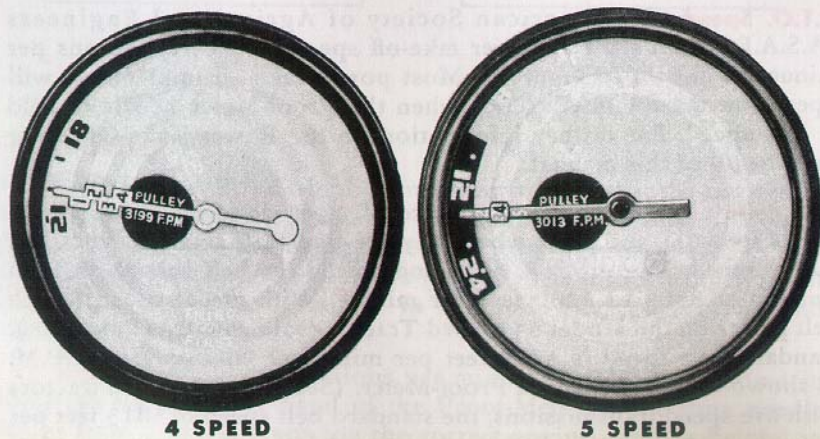

Figure 10
Belt Pulley Speed

OPERATION

Your new Ford Tractor has been built with the knowledge gained through manufacturing over two million farm tractors. In it you will find many new and exclusive features, designed to make your work easier, faster and more profitable.

After familiarizing yourself with the tractor controls and instruments, read the following instructions on OPERATION. They will help you obtain maximum efficiency and dependable operation from your new Ford Tractor.



*A careful operator is the best insurance
against accidents.*

OPERATION

PRE-STARTING CHECK

Your Ford Tractor and Implement Dealer has checked your tractor thoroughly. We suggest, however, that you double check the tractor before placing it in operation. Make certain that the crankcase, transmission, hydraulic system and rear axle are filled to the recommended level. Check the tires for proper air pressure and be sure that the radiator is filled with coolant.

FUEL

Ford high compression gasoline engines are designed to operate most efficiently with the anti-knock qualities in good regular grade gasoline. The use of poor quality fuel can cause knocking, overheating and engine failure.

BREAK-IN PROCEDURE

Your new Ford Tractor should provide long and dependable service if given a good start by you, the operator. During the first 50 hours of operation, do not work the tractor at full capacity. Run the engine at slow to medium speeds and use the lower gears wherever possible. Check the instruments frequently and keep the radiator and oil reservoirs filled to the recommended level.

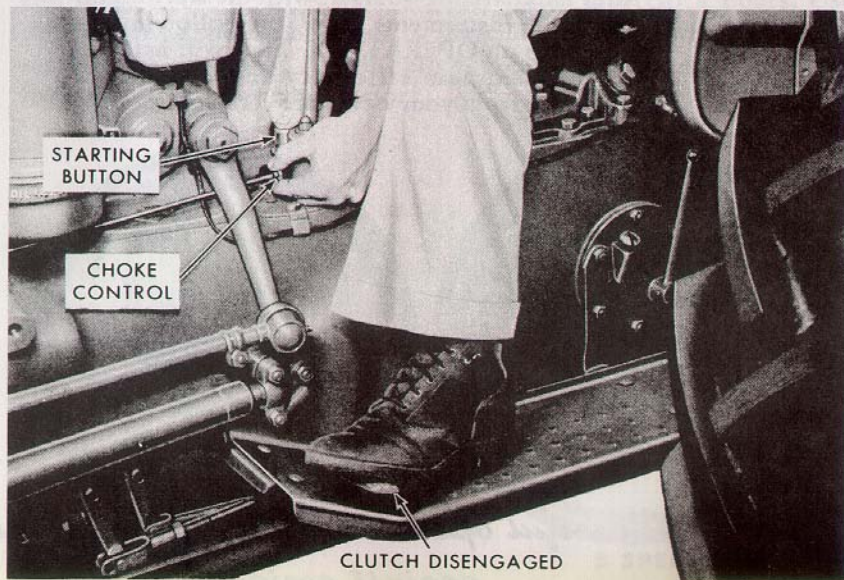

Figure 11
Using the Starter Button, Choke and Clutch Pedal

After 50 hours of operation, see your Ford Tractor and Implement Dealer. He will perform all necessary checks and adjustments in the **50 HOURS SERVICE AND INSPECTION**, authorized by your Service Policy.

STARTING THE ENGINE

To start the engine under normal weather conditions, move the throttle lever to approximately $\frac{1}{4}$ open position, set the gear shift lever in neutral and turn the ignition key clockwise. Then, simply depress the clutch pedal and press the starter.

Initial starting of the engine, may require the use of the choke. Under these conditions, pull out the choke control and depress the starting button at the same time. As soon as the engine starts, push the choke in to its normal operating position. Run the engine at about 1000 RPM until it warms up before placing it under a load.

OPERATING THE TRACTOR

Start the engine, release both rear wheel brake locks and depress the clutch pedal. Next, move the gear shift lever to the desired gear speed. The shift positions are clearly indicated on the transmission cover and are shown in Figure 2.

You will save fuel and minimize engine wear by selecting the correct gear ratio for a particular field operation. Operating the tractor in low gear with a light load and high engine speed is a waste of fuel. "Lugging" occurs when the load for a particular gear and throttle setting is excessive.

After shifting to the desired gear speed, increase the engine speed slightly and release the clutch pedal in the same manner as you would when driving an automobile. When the tractor is in motion, increase the ground speed as desired and remove your foot from the clutch pedal.

To stop the tractor, depress the clutch pedal and decrease the engine speed. Apply pressure evenly to both brake pedals until the tractor is stopped, then place the gear shift lever in the neutral position, lock the brakes and turn the ignition key off. If the engine is hot, let it idle for a few seconds before turning the ignition key off.

CAUTION: DO NOT ATTEMPT TO SHIFT GEARS WHILE THE TRACTOR IS IN MOTION. DO NOT TOW TRACTOR FASTER THAN 20 M.P.H.

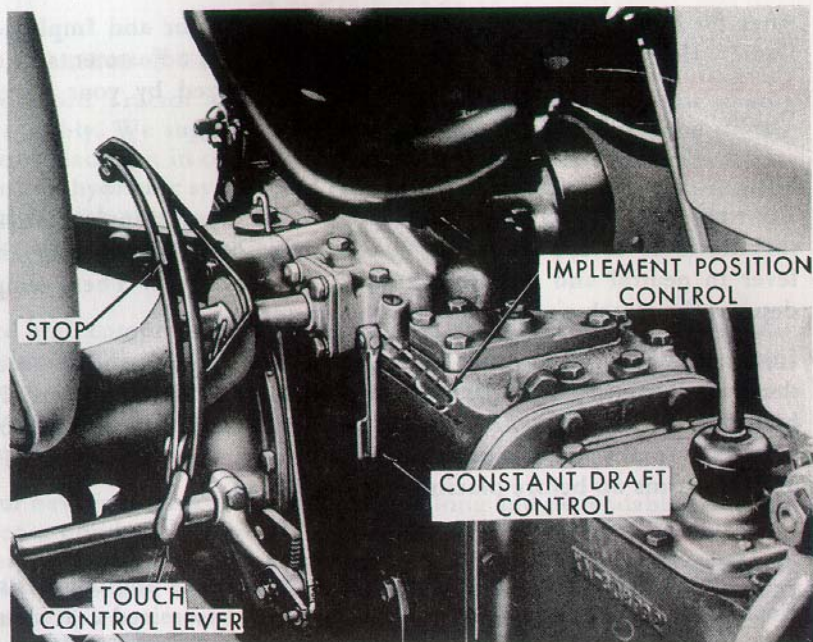

Figure 12
Hydraulic Control Levers

OPERATING THE HYDRAULIC SYSTEM

One of the outstanding features of your new Ford Tractor is the Live Action Hydraulic System. By simply moving the Touch Control Lever, the system provides instant hydraulic power for raising a wide variety of implements. Regardless of whether the clutch pedal is up or down, or whether the P.T.O. is engaged or disengaged, the system will respond smoothly, enabling you to adjust implements in fractions of an inch.

The system incorporates two types of hydraulic control. Depending upon the type of implement used and the soil conditions and terrain encountered, the system may be operated in Implement Position Control or in Constant Draft Control.

Implement Position Control: To operate the hydraulic system in Implement Position Control, move the selector lever at the side of the tractor seat into the "UP" position (see Figure 12), and set the implement at the desired depth by moving the Touch Control Lever down. Where the ground is relatively level, the position control will keep the implement at the desired depth, even though the soil texture may vary.

By setting the adjustable stop on the quadrant, the implement can always be returned to the original depth by moving the Touch Control Lever down to the stop.

Constant Draft Control: With the selector lever in the "DOWN" position, as shown in Figure 12, the hydraulic system is operating in Constant Draft Control. When an implement is lowered to work at a certain depth, the draft control will maintain the same draft, even though the ground contour or soil texture may change. If the draft increases, the hydraulic system will respond by raising the implement to decrease the draft. At the same time, the weight will shift to the tractor rear wheels, increasing traction until the implement has been automatically repositioned and the draft is decreased.

When necessary, the operator may use the Touch Control Lever to make small adjustments in the system.

Hydraulic Piston Pump: Your new Ford Tractor is equipped with a piston-type hydraulic pump which provides a constant flow of oil to the Ford Tractor "live action" hydraulic system.

For maximum efficiency and long pump life, always use the recommended hydraulic fluid and clean containers when filling the tractor hydraulic reservoir. When service on the hydraulic system becomes necessary, see your local Ford Tractor and Implement Dealer. He is properly equipped to meet your service needs.

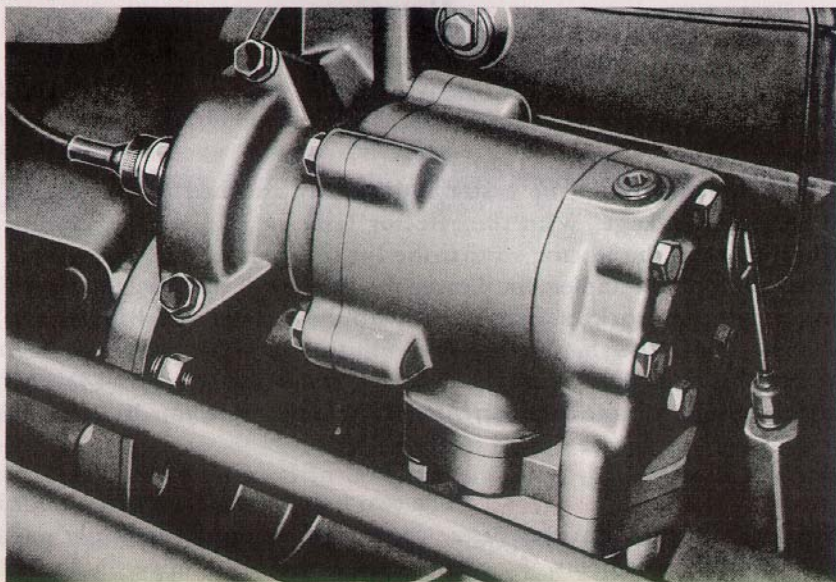

Figure 13
Hydraulic Piston Pump

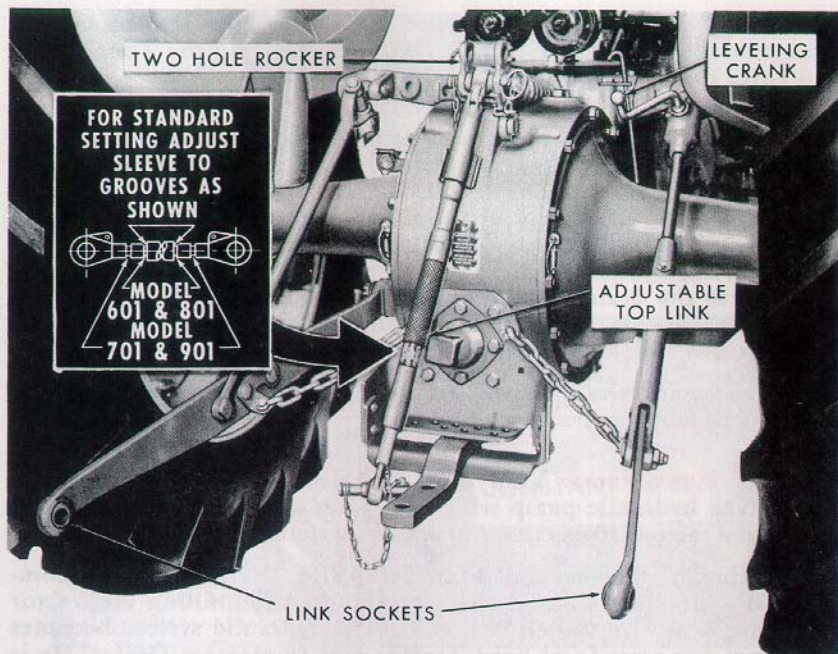

Figure 14
Leveling Crank and Adjustable Top Link

ATTACHING IMPLEMENTS

Most implements can be easily and quickly attached to the tractor three point linkage. With the selector lever in Implement Position Control, back the tractor so that the lift links are directly above the cross shaft of the implement. Lower the links with the Touch Control Lever, until the sockets are aligned with the ends of the shaft. Attach the left link to the shaft and secure with the linch pin provided, then adjust the right link with the leveling crank (see Figure 14) and attach it in the same manner. Attach the adjustable top link to the implement and secure it with the linch pin.

Two Hole Hydraulic Lift Rocker: The two hole hydraulic lift rocker on the Ford Tractor provides better control of sensitivity for light and heavy draft implements. Attach the top link in the upper hole for light draft loads (cultivating) and in the lower hole for heavy draft loads such as plowing.

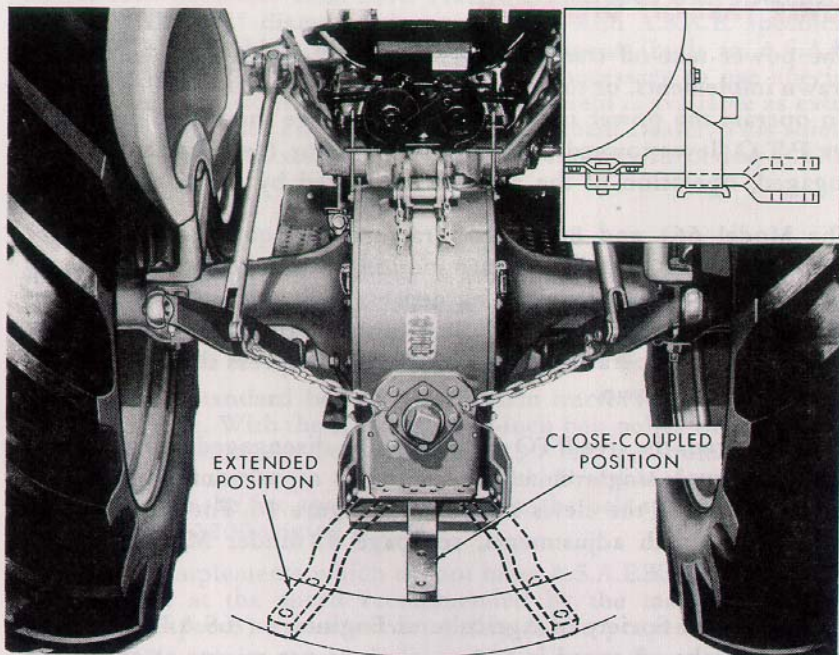

Figure 15
Swinging Drawbar

Adjustable Top Link: The fully adjustable top link provides improved implement performance and operation. The link may be adjusted to suit implement operation requirements by releasing the lock and rotating the sleeve until the desired length is obtained. The standard length of 25 inches is obtained by adjusting the link as shown on a decal located on the sleeve. (See insert, Figure 14.)

SWINGING DRAWBAR:

The swinging drawbar on your Ford Tractor, permits quick, easy attachment of pull type implements.

The tractor can be operated with the swinging drawbar in either the "close-coupled" or "extended" positions (see Figure 15), and with the offset up or down (see insert, Figure 15). The drawbar may also be set and used in different positions either to the left or right of center (seven in all).

When operating with P.T.O. driven equipment, the drawbar should always be in the "extended" position, with offset down.

CAUTION: Remove the Swinging Drawbar when attaching close mounted implements.

POWER TAKE-OFF OPERATION

The power take-off transfers engine power directly to mounted or drawn implements, or to belt driven equipment when a pulley is used. To operate the power take-off shaft, disengage the clutch and move the P.T.O. lever toward the rear of the tractor (see Figure 4). Once engaged, operation of the shaft is controlled by the tractor clutch.

The Model 661 and 861 Ford Tractors are equipped with a live PTO clutch. To stop the forward motion of the tractor when operating with PTO driven equipment, depress the clutch pedal about half way as shown in Figure 16. To stop both the forward motion of the tractor and the operation of the implement, depress the clutch pedal all the way, as shown.

When desired, the live PTO clutch may be disengaged and the pedal set for normal, single clutch operation by repositioning the pin in the front hole of the clevis as shown in Figure 16. For further information on clutch adjustments, see page 48 under MECHANICAL MAINTENANCE.

The American Society of Agricultural Engineers (A.S.A.E.) standard for power take-off speed is 540 revolutions per minute as shown on the Proof-Meter. Most power take-off implements are designed to operate at this speed.

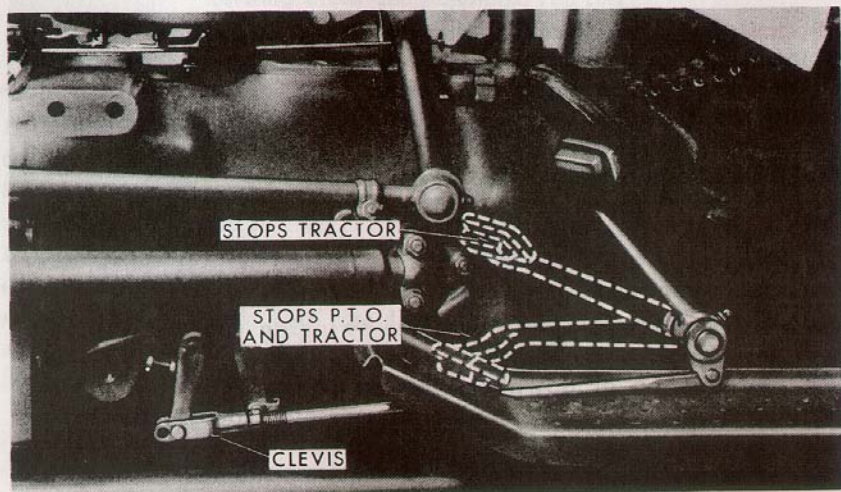

Figure 16
Operating the Live PTO Clutch

Power Take-Off Shaft: Your Ford Tractor is equipped with a standard P.T.O. shaft (1 $\frac{3}{8}$ " diameter) in accordance with A.S.A.E. specifications. When attaching P.T.O. driven equipment (built to A.S.A.E. standards) to your Ford Tractor, it is not necessary to use special adaptors or extensions. However, a P.T.O. shield is available as extra equipment from your Ford Tractor and Implement Dealer. This shield should be used as a safety factor in all operations involving P.T.O. driven implements.

BELT PULLEY

A nine-inch diameter belt pulley is available as an accessory for use on your Ford Tractor. The pulley can be installed in any one of three positions, by simply removing the P.T.O. shaft safety cap, drawbar, drawbar hanger, and check chains.

The A.S.A.E. standard belt speed for farm tractors is 3000 to 3200 feet per minute. With the standard nine-inch belt pulley on the Model 641 Ford Tractor, the belt speed is 3199 feet per minute at 2000 engine R.P.M. as shown on the four speed Proof-Meter. On models equipped with the five speed transmission, the belt speed is 3013 feet per minute at 2200 engine R.P.M.

Belt driven implements which do not meet A.S.A.E. standards should be operated at the speed recommended by the manufacturer. To obtain this speed, select a driven pulley of the proper size from the table below.

PROPER SIZE OF THE DRIVEN PULLEY*

Engine R.P.M. 4 Speed Transmission	Engine R.P.M. 5 Speed Transmission	Pulley R.P.M.	R.P.M. OF THE DRIVEN PULLEY								
			600	800	1000	1200	1400	1800	2200	2600	3000
1000	1168	679	10	7 $\frac{1}{2}$	6	5	4 $\frac{1}{2}$	3 $\frac{1}{2}$	3		
1100	1285	747	11	8 $\frac{1}{2}$	6 $\frac{1}{2}$	5 $\frac{1}{2}$	5	3 $\frac{1}{2}$	3		
1200	1402	815	12	9	7 $\frac{1}{2}$	6	5	4	3 $\frac{1}{2}$	3	
1300	1517	882	13	10	8	6 $\frac{1}{2}$	5 $\frac{1}{2}$	4 $\frac{1}{2}$	3 $\frac{1}{2}$	3	
1400	1634	950	14	10 $\frac{1}{2}$	8 $\frac{1}{2}$	7	6	4 $\frac{1}{2}$	4	3 $\frac{1}{2}$	3
1500	1751	1018	15	11 $\frac{1}{2}$	9	7 $\frac{1}{2}$	6 $\frac{1}{2}$	5	4	3 $\frac{1}{2}$	3
1600	1868	1086	16 $\frac{1}{2}$	12	10	8	7	5 $\frac{1}{2}$	4 $\frac{1}{2}$	4	3 $\frac{1}{2}$
1700	1985	1154	17 $\frac{1}{2}$	13	10 $\frac{1}{2}$	8 $\frac{1}{2}$	7 $\frac{1}{2}$	6	4 $\frac{1}{2}$	4	3 $\frac{1}{2}$
1800	2102	1222	18 $\frac{1}{2}$	13 $\frac{1}{2}$	11	9	8	6	5	4	3 $\frac{1}{2}$
1900	2219	1290	19 $\frac{1}{2}$	14 $\frac{1}{2}$	11 $\frac{1}{2}$	9 $\frac{1}{2}$	8 $\frac{1}{2}$	6 $\frac{1}{2}$	5 $\frac{1}{2}$	4 $\frac{1}{2}$	4
2000	—	1358	20 $\frac{1}{2}$	15 $\frac{1}{2}$	12	10	8 $\frac{1}{2}$	7	5 $\frac{1}{2}$	4 $\frac{1}{2}$	4

*Figures are computed to the nearest $\frac{1}{2}$ inch pulley size.

CAUTION: NEVER INSTALL OR REMOVE BELT WHILE PULLEY IS IN MOTION.

WHEEL TREAD ADJUSTMENTS

The unique design of the Ford Tractor permits a wide range of front and rear wheel adjustments which can be made quickly and easily.

Front Wheel Tread Adjustment: The front wheels are adjustable from 52 to 76 inches in 4 inch spacings. To change the tread width, raise the front end of the tractor with a jack and remove the bolts which

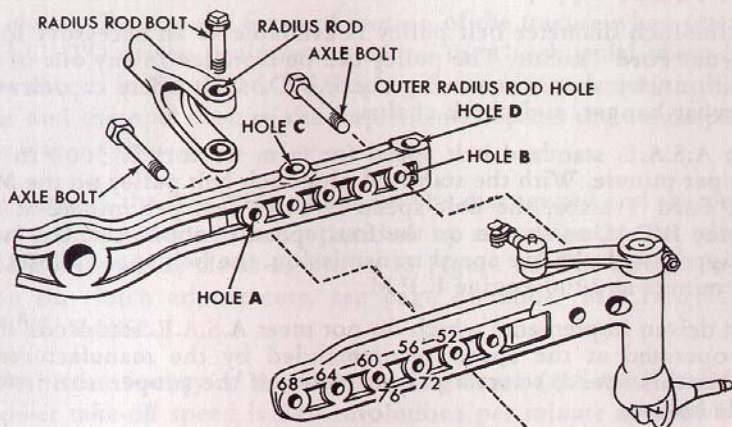

FOR TREAD WIDTH (INCHES)	LINE UP HOLE A AND HOLE NO.	LINE UP HOLE B AND HOLE NO.	SPACE BOLTS APART (INCHES)	SET RADIUS ROD TO HOLE	RADIUS RODS SPREAD (INCHES)
52	52		8½	C	29.08
56	56		8½	C	29.08
60	60		6¾	D	40.82
64	64		8½	D	40.82
68	68		8½	D	40.82
72		72	6¾	D	40.82
76		76	4¼	D	40.82
80†		72	6¾	D	40.82

† REVERSE WHEELS ON AXLE HUBS.

NOTE: ADJUST DRAG LINKS—SEE FRONT WHEEL TOE-IN

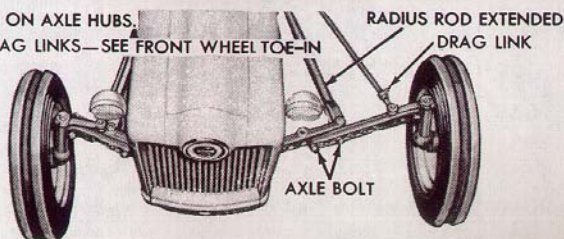

Figure 17
Front Wheel Tread Adjustments

hold the outer axle sections to the center section. Move the front wheels apart until the desired tread width is obtained (see Figure 17), then replace the bolts and tighten securely. Always leave one or more open holes between the bolts.

When absolutely necessary, an 80 inch tread width can be obtained by setting the axle for the 72 inch tread width and then reversing the wheels.

NOTE: When front wheel adjustments are made, the drag links must be adjusted to obtain proper front wheel toe-in. See page 49, under MAINTENANCE.

Rear Wheel Tread Adjustments: The tractor rear wheels are adjustable to the same tread widths as the front wheels. Tread width settings are made by changing the position of the steel discs and the rims to any of the positions from 52 inches to 76 inches shown in Figure 18. To

INTER-CHANGING REAR WHEEL ASSEMBLIES GIVE THESE COMBINATIONS

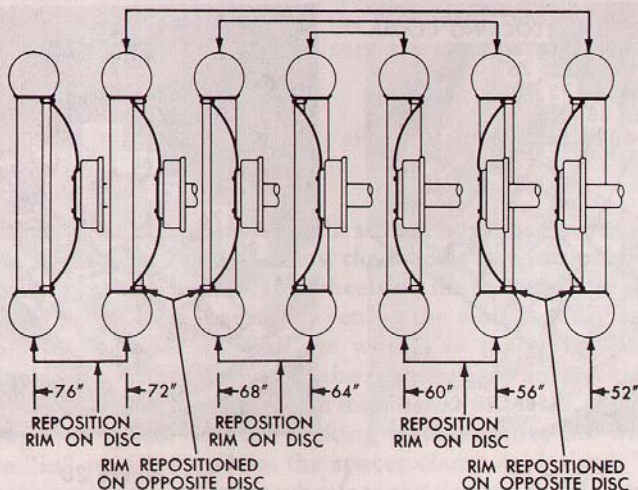

Figure 18
Rear Wheel Tread Adjustments

change from the 52 inch tread width to the 72 inch width, it is only necessary to change the wheels from one side of the tractor to the other. Two other wheel changes are similar as shown at the top of Figure 18.

NOTE: THE ARROW ON THE SIDE WALL OF THE TIRE SHOULD ALWAYS POINT IN THE DIRECTION OF FORWARD ROTATION OF THE WHEEL.

POWER ADJUSTED REAR WHEELS: If your Ford Tractor is equipped with Power Adjusted Rear Wheels, you will be able to change the rear wheel tread width quickly and easily by means of tractor power.

The wheels may be spaced from 56 to 84 inches in 2 inch intervals. For tread widths of 56 to 76 inches, adjust the wheels, one at a time, as follows.

LOOSENING TIRE RIM FROM DISC: Loosen the nuts on the three locking clamps (see Figure 19), slide the clamps toward the center or retracted position, then retighten the nuts securely. Move the tractor until the wheel tread spacer clamp (Figure 19) is at the top of the wheel, then remove the spacer clamp from the disc by removing the nut.

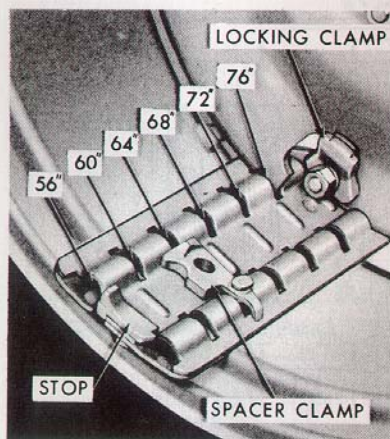

Figure 19
Adjusting Wheels
(Normal Position)

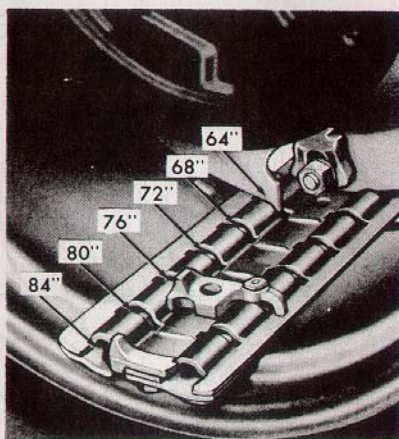

Figure 20
Adjusting Wheels
(Reversed Position)

OPERATING WHEEL DISC IN THE RIM: When setting a wheel at the extreme inner or outer position, loosen the tire rim from the disc as described above, then simply move the wheel in or out to either end stop.

For settings between 56 and 76 inches, first move the wheel to the extreme outer position by engaging the clutch, with the tractor engine at idle speed. Use reverse gear for the left wheel and forward gear for the right wheel.

NOTE: Brake the opposite wheel slightly and allow the tractor to creep forward or rearward while the wheel is being adjusted.

Next, place the spacer clamp in the channel thread bar which has stops at each end. Position the clamp for desired tread width and secure as shown in Figure 19. These settings will permit a full revolution, or adjustment of 2 inches for the wheel.

Rotate the disc back into the rim by engaging the clutch with the engine at idling speed. Use reverse gear for the right wheel and forward gear for the left wheel. Disengage the clutch as soon as the disc strikes the spacer clamp.

SECURING RIM IN POSITION: Move the tractor so that the spacer clamp can be replaced at the top of the wheel, then remove the clamp from the rim and reinstall it in the wheel. Tighten the nut securely.

Loosen the nuts which hold the three locking clamps. Move the clamps out to the lock position, then center the rim in the wheel by tightening the bottom locking clamp. Secure the remaining two clamps. Tighten the nuts in sequence, and make sure the clamps are positioned at approximately the same angle.

NOTE: Check the nuts for tightness after the tractor has been operated for a short time.

CHANGING WHEEL DISCS: To obtain a tread width setting of 80 inches, it is only necessary to power-adjust the wheels to a normal 60" setting (see Figure 19), then reverse the wheels on the tractor. The 84" setting is obtained in the same manner by setting the wheels at 56" and reversing them on the tractor. With the wheels in the reversed (dish in) position, it will be necessary to set the spacer clamp and locking clamps from the inside of each wheel when making adjustments. See Figure 20. Disengage the spacer and the locking clamps, move the wheel to its extreme "in" position and set the spacer clamp as desired. Then, use the tractor power to adjust the wheels to the desired width. After adjusting, replace the spacer clamp and locking clamps and tighten securely.

NOTE: THE ARROW ON THE SIDE WALL OF THE TIRE SHOULD ALWAYS POINT IN THE DIRECTION OF FORWARD ROTATION OF THE WHEEL.

WHEEL WEIGHT

To assure sufficient traction for maximum performance in heavy draft operations, weight should be added to the Ford Tractor.

Liquid Ballast: It is a common practice to add weight by filling the rear tractor tires with liquid. A solution of calcium chloride is recommended because of its lower freezing point, and greater weight per gallon than water.

The use of liquid ballast in the front tires will help counter-balance heavy rear mounted implements, and will further increase the traction and "pull-power" of your Ford Tractor in heavy draft operations.

The recommended liquid capacities for tires are shown in the table below. This table is based on a 90% fill of the tires with 5 pounds of calcium chloride per gallon of water. The addition of this amount of calcium chloride will prevent freezing in most locations. A 90% fill of tires requires special equipment. See your Ford Tractor and Implement Dealer. For valve level filling of the tires listed, multiply the respective figures in the table by .8 to obtain the necessary information.

MAXIMUM CALCIUM CHLORIDE SOLUTION CAPACITIES

Size of Tire	Pounds of Calcium Chloride	Gallons of Water	Weight of Solution
10-28 4-ply	116	23	310 lbs.
11-28 4-ply	164	32	440 lbs.
12-28 4-ply	187	38	504 lbs.
6:00-16 4-ply	30	6	80 lbs.
5:50-16 4-ply	25	5	65 lbs.

Cast Iron: In heavy work such as plowing and discing, added weight is necessary in most cases to provide sufficient traction to utilize the maximum power of the engine. Special cast iron weights are available, at extra cost, in different sizes for use on the Ford Tractor. These individual weight sections can be easily attached to or detached from the wheels as the job requires. On lighter jobs, removal of the weights will increase the operating economy of your tractor. The following chart describes the different types of weights and their recommended usage.

FORD TRACTOR WHEEL WEIGHTS FOR ALL PURPOSE AND SPECIAL UTILITY MODELS	SERIES 601		SERIES 801	
	Farm Use	Industrial Use	Farm Use	Industrial Use
FRONT (per tractor set) Wheel Weights—Inside mounted Two per wheel—50 lbs. each Total—200 lbs.	X	X	X	X
REAR (per tractor set) Regular Duty Weights Two Mounting Discs—68 lbs. Segments—(24) 30 lbs. each Bolts—12 lbs. Total—800 lbs. *Heavy Duty Weights Two Mounting Discs—68 lbs. Segments—(24) 45 lbs. each Bolts—12 lbs. Total—1160 lbs. Inside Segmented (Special Utility) Segments (6)—133 lbs. each Total—798 lbs.	X	X	X	X

***CAUTION:** Under no circumstances should Heavy Duty Weights be used on Series 601 Tractors.

Weight added to the tires, together with the weight of the mounted implement and tractor, should not exceed the recommended weight to be carried by the tires. The following table lists the maximum recommended weight that can be carried without overloading the tires.

Tire Size	Inflation Pressure	Maximum Lbs. Tire Load Per Wheel
Rear:		
10-28 4-ply	12	1575
11-28 4-ply	12	1890
	14	2070
12-28 4-ply	14	2430
Front:		
5.50—16 4-ply	20	655
5.50—16 4-ply	24	725
5.50—16 4-ply	28	795
5.50—16 4-ply	32	860
6.00—16 4-ply	20	750
6.00—16 4-ply	24	835
6.00—16 4-ply	26	875

Watch Your Proof-Meter Decal

WATCH YOUR PROOF-METER

EVERY 10 HOURS	Lubricate All Fittings. Check Air Cleaner. Check Engine Oil.
EVERY 100 HOURS	Change Engine Oil. Check Oil Level in Steering Housing, Hydraulic System, Transmission and Rear Axle, Pedestal and Both Right and Left Final Drives.
EVERY 200 HOURS	Change Oil Filter. Oil Rear Generator Bearing. Lubricate Distributor Cam.
EVERY 400 HOURS OR MORE OFTEN	Repack Front Wheel Bearings. High Grade Short Fibre Grease. Remove and Clean Air Cleaner Assembly. Change Oil in Transmission, Rear Axle and Hydraulic System and Both Right and Left Final Drives.

FOLLOW SEASONAL REQUIREMENTS BELOW

Engine Oil	WINTER (Below 32°F) S. A. E. 10W or 20W	SUMMER (Above 32°F) S. A. E. 20 or 30
Hydraulic System	(Below 10°F) Mix 3 Parts M-4864-A With 1 Part M-4864-D	(Above 10°F) M-4864-A
Transmission, Rear Axle Pedestal and Both Final Drives	Use Ford Tractor Hydraulic Oil M-4864-A Winter and Summer	

BATTERY CHECK AND FILL WITH CLEAN WATER WEEKLY

WARNING!

SERVICE AIR CLEANER DAILY
VERY DUSTY CONDITIONS TWICE DAILY
USE S. A. E. 30 OIL ABOVE 40°F
USE S. A. E. 10W OIL BELOW 40°F
AIR INLET SCREEN MUST BE KEPT
CLEAN AND FREE FROM OIL
CLEAN BOTTOM FILTER AND
CENTER TUBE MONTHLY
KEEP HOSE CONNECTIONS TIGHT
USE OF ADDITIONAL CLEANERS
NOT RECOMMENDED

THIS TRACTOR IS CONSTRUCTED
UNDER ONE OR MORE OF THE
FOLLOWING UNITED STATES
LETTERS PATENT

2,468,809	2,563,277
2,488,469	2,624,257
2,507,000	2,631,514
2,540,458	2,631,515

Other Patents Pending

MADE IN U.S.A.



REG. U. S. PAT. OFF.

**CALL YOUR FORD TRACTOR DEALER
FOR SERVICE . . . USE ONLY
GENUINE FORD TRACTOR PARTS . . .**

TRACTOR

To emphasize the importance of establishing regularly scheduled lubrication periods, a copy of the above decal is fixed to the inside of every tractor hood. The information on the decal has been condensed from the lubrication information on pages 30 through 35. Watch your Proof-Meter and use the decal as a reminder of the lubrication services required by your tractor.

MAINTENANCE

How long and how well your Ford Tractor continues to give satisfactory performance depends largely upon proper maintenance. Keep the tractor in good working order by following the instructions in this section on lubrication, mechanical maintenance, minor adjustments and storage.

When major overhauls become necessary, see your Ford Tractor and Implement Dealer. He is interested in you and your tractor, and is properly equipped to meet your service needs.



*A properly maintained tractor
is a Safe tractor.*

MAINTENANCE

PRE-DELIVERY INSPECTION

Before your tractor was delivered to you, the dealer performed a pre-delivery inspection which is the first step in the maintenance schedule of your tractor. Some of the more important items checked by your dealer are the cooling system, front end, engine, transmission, hydraulic system, rear end, and the general physical condition of your new tractor. A detailed listing of the inspections performed is shown on your Service Policy under the Pre-Delivery and 50-Hour Inspection Reports.

50 HOUR INSPECTION

After you have operated your tractor for a period of fifty hours, see your Ford Tractor and Implement Dealer. At this time, he will perform the factory recommended 50-Hour Inspection, without charge, except for lubricants. Remember that the dealer is interested in your tractor's performance. See him periodically for continued good service.

LUBRICATION

Since your tractor will be subjected to a variety of operating conditions, it is extremely important that all moving parts be lubricated at the proper time. Avoid causing serious damage to your tractor by using clean containers and recommended grades of lubricant.

The following guide describes, in hourly intervals, all of the lubrication services required by your tractor. These time intervals are based on average working conditions. When operating under extremely hot or dusty conditions, lubricate the tractor more frequently.

The location of the lubrication points described in the lubrication guide are shown in Figures 25 and 26 on pages 34 and 35.

SERVICE DAILY OR EVERY TEN HOURS

Crankcase Ventilating System: Remove the element in the Rocker Arm Cover Breather and clean with a suitable solvent. Coat the element with light engine oil before replacing.

Oil Filler Breather Cap: Remove the element, clean the entire assembly with solvent and coat the element with light engine oil.

Air Cleaner: Remove the oil cup and clean with a suitable solvent. Refill the cup with 1.3 pints of engine oil for Series 801 tractors, 0.8 pints for Series 601 tractors. (Under extremely dusty conditions, service more often.)

Pressure Type Fittings: Clean the fittings on the Lift Rod Leveling Box and Fork, Front Axle Spindles, Clutch Pedal and Steering Drag Links. Apply pressure gun grease and wipe the fittings clean. See Figure 25.

Distributor: Place a few drops of seasonal engine oil in the oil cup. Do not over lubricate. (See Figure 22.)

Crankcase Dip Stick: Remove the dip stick from the right side of the engine crankcase. Always wipe the dip stick with a clean cloth, replace it and then remove it again to determine the oil level. Maintain the level at the full mark with a good grade of heavy duty or premium engine oil. (See SERVICE EVERY 100 HOURS.)

Hydraulic System Dip Stick: Check the level of the hydraulic oil on the dip stick and maintain at the full mark with the proper lubricant as recommended under SERVICE EVERY 600 HOURS. *When checking the hydraulic oil level, always be sure all hydraulic cylinders are fully extended.*

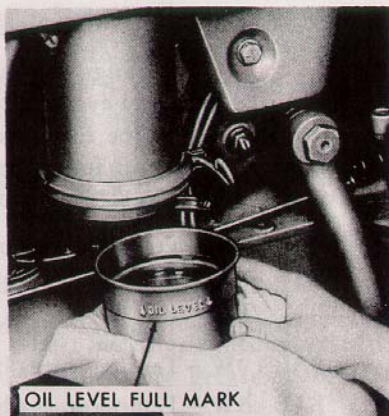

Figure 21
Checking the Air Cleaner Oil Level

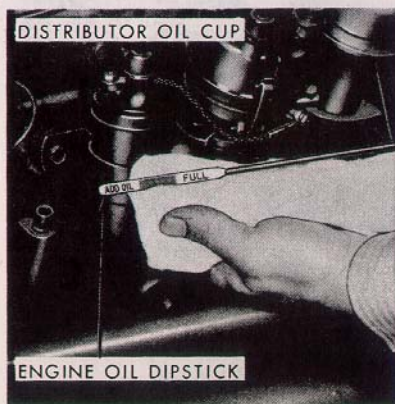

Figure 22
Crankcase Oil Level Dip Stick

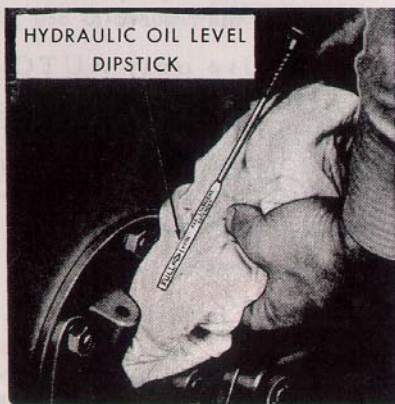

Figure 23
Hydraulic Oil Level Dip Stick

SERVICE EVERY 100 HOURS

Engine Crankcase: Change the engine oil in your new tractor at the 50 Hour inspection and every 100 hours of operation thereafter. Drain the oil after the engine has reached normal operating temperature. Refill the crankcase with four quarts of good heavy duty or premium engine oil and add one extra quart of oil if the filter cartridge is replaced.

SAE 30 —Temperatures consistently above 90° F.

SAE 20 —Temperatures between 90° F. and 32° F.

SAE 20W—Temperatures between + 32° and + 10° F.

SAE 10W—Temperatures between + 10° F. and - 10° F.

SAE 5W—Temperatures below - 10° F.

Rear Axle: Remove the rear axle inspection plug (11), Figure 25, and check the level of the oil. If necessary, add oil. (See SERVICE EVERY 600 HOURS.)

Transmission: Remove the transmission oil level inspection plug (19), Figure 25, and add oil, if required. (See SERVICE EVERY 600 HOURS.)

Steering Housing: Check the oil level at the steering gear case plug (17), Figure 25, and add lubricant as required. Use extreme pressure gear lubricant SAE 90 in the summer and SAE 80 in the winter.

Power Steering Pump Reservoir: Check the oil level every 100 HOURS OF OPERATION. Maintain the oil level as indicated on the dipstick attached to the filler cap. Refer to the decal on the reservoir.

CAUTION: Use only AUTOMATIC TRANSMISSION FLUID—TYPE "A" in the Power Steering System. Always use clean fluid. Dirty fluid may cause extensive damage to the system.

SERVICE EVERY 200 HOURS

Oil Filter: Replace the filter cartridge with every other engine oil change and add one quart of engine oil to fill the new cartridge.

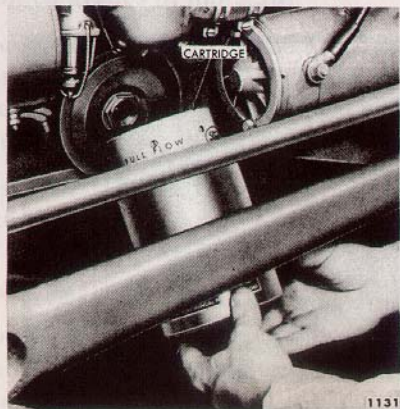

Figure 24
Replacing the Oil Filter
Cartridge

Distributor: Remove the cap and dust shield. Wipe the cam, the outside of the distributor, the wires and the coil with a clean cloth. Apply a portion of roller bearing lubricant about the size of a match head on the distributor cam. Use roller bearing lubricant only.

Generator: Oil the generator rear bearing with light oil. Do not over lubricate.

SERVICE EVERY 600 HOURS

Front Wheel Bearings: Clean the front wheel bearings thoroughly with a solvent and repack with a high grade short fibre grease. Lubricate the spindle shaft before replacing the bearings.

Transmission: Change the transmission oil at the 50 hour inspection and every 600 hours of operation thereafter. In winter operate the tractor to thin the oil before draining. Fill the 4 speed transmission with 6½ quarts of mild extreme pressure lubricant and the 5 speed transmission with 8½ quarts.

Use mild extreme pressure lubricant SAE 80, both summer and winter.

Hydraulic System: After the first 50 hours and after every 600 hours operation, change the oil in the hydraulic system. In winter, operate the system to thin the oil before draining. Clean the fill port carefully before removing to prevent dirt from entering the system. Fill the system with 8 quarts of M-4864-A hydraulic oil at temperatures above 10° F. At temperatures below 10° F., use 6 quarts of M-4864-A and 2 quarts of M-4864-D hydraulic oil.

Rear Axle: Replace the oil in the rear axle after the first 50 hours of operation and following every 600 hours thereafter. In winter, operate the tractor to thin the oil before draining. Refill Series 601 axles with 8 quarts of oil, and Series 801 axles with 11½ quarts.

Use mild extreme pressure lubricant SAE 80, both summer and winter.

NOTE: *The tractor rear wheel bearings are sealed and require no further lubrication for the life of the tractor.*

LUBRICATION

EVERY 10 HOURS

- 16 CRANKCASE VENTILATING SYSTEM—
Clean and Oil
- 12 OIL FILTER BREATHER CAP—Clean and Oil
- 6 AIR CLEANER—
Clean and Oil
- 13 DISTRIBUTOR—Few
Drops of Engine Oil in Cup
- 15 CRANKCASE DIP
STICK—Check Oil Level
- 20 HYDRAULIC SYSTEM
DIP STICK—
Check Oil Level

LUBRICATE PRESSURE FITTINGS BELOW:

- 2 DRAG LINKS (FRONT)
- 27 POWER CYLINDER
- 4 SPINDLE PINS
- 18 DRAG LINKS (REAR)
- 7 CLUTCH PEDAL
(4-Speed)
- 9 CLUTCH PEDAL
(OTHERS)
- 22 LEVELING BOX

TOP VIEW OF TRACTOR

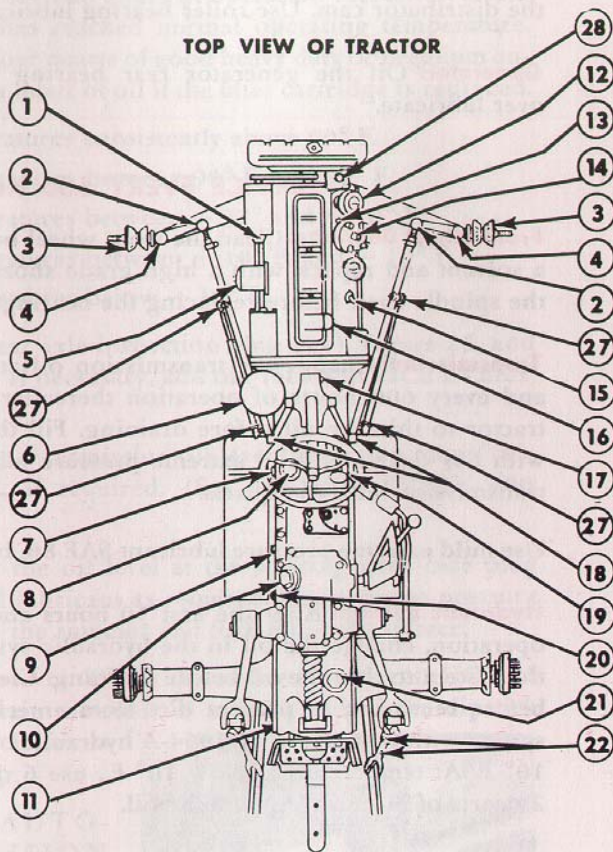

Figure 25

EVERY 100 HOURS

- | | |
|--|--|
| 28 PUMP RESERVOIR—Check Oil Level and Replenish with Automatic Transmission Fluid—Type "A" | 11 REAR AXLE—Check Oil at Level Plug on and Side of Housing and Add Oil if 21 Necessary. |
| 23 ENGINE CRANKCASE—Drain and Refill: and Winter (Below 32° F.) S.A.E. 10W or 20W 12 Summer (Above 32° F.) S.A.E. 20 or 30 | 19 TRANSMISSION—Check Oil at Level and Plug on Side of Housing and Add Oil if 8 Necessary. |
| 20 HYDRAULIC SYSTEM—Check Oil Level | 17 STEERING HOUSING—Check oil level. |

CHART

UNDERSIDE VIEW OF TRACTOR

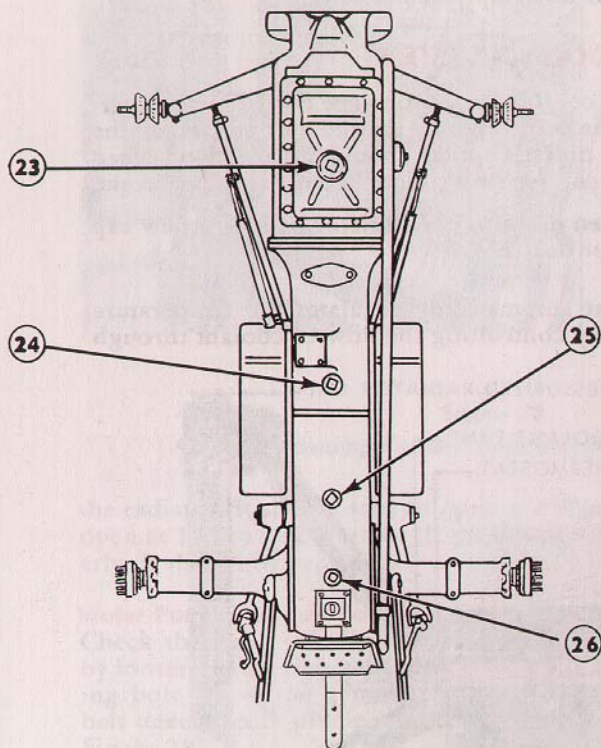

Figure 26

EVERY 600 HOURS

- 3 FRONT WHEEL BEARINGS**—Repack with High Grade Short Fibre Grease
- 24 TRANSMISSION**—Drain and Refill (Use Mild Extreme Pressure Lubricant SAE 80, Both Summer and Winter)
- 25 HYDRAULIC SYSTEM and**—Drain and Refill (Below 10° F.—Mix 6 Qts. M-4864-A with 2 Qts. M-4864-D) (Above 10° F.—8 Qts. M-4864-A)
- 26 REAR AXLE**—Drain and Refill (Use Mild Extreme Pressure Lubricant SAE 80, Both Summer and Winter)

EVERY 200 HOURS

- 5 OIL FILTER**—Replace cartridge every other engine oil change and add one quart of oil to fill new cartridge.
- 1 GENERATOR**—Oil rear bearing with light oil. Do not over lubricate.
- 14 DISTRIBUTOR**—Light Film of Distributor Lubricant on Cam

MECHANICAL MAINTENANCE

In addition to lubrication services, regular mechanical maintenance is necessary to keep your tractor performing at maximum efficiency. The information in this section has been prepared to help you perform certain routine jobs on your tractor. Avoid breakdowns during the busy seasons by checking these items frequently and making the necessary repairs or adjustments. For major repair work or service parts, see your Ford Tractor and Implement Dealer.

COOLING SYSTEM

Radiator Pressure Cap: The cooling system on your Ford Tractor operates under pressure which is controlled by the radiator cap. Keep the cap installed tightly at all times. Caution should be exercised when removing the cap to prevent possible injury from escaping steam.

Always remove the cap when draining the radiator. If lost, a new cap may be purchased from your dealer.

Thermostat: The thermostat automatically regulates the temperature within the cooling system by controlling the flow of coolant through

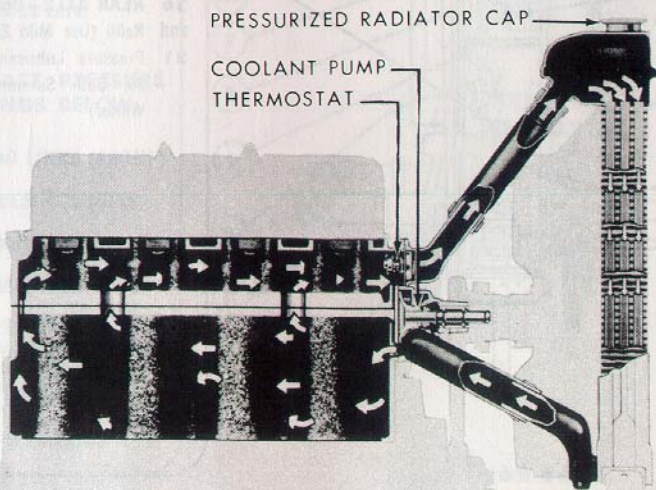

Figure 27
Ford Tractor Engine Cooling System

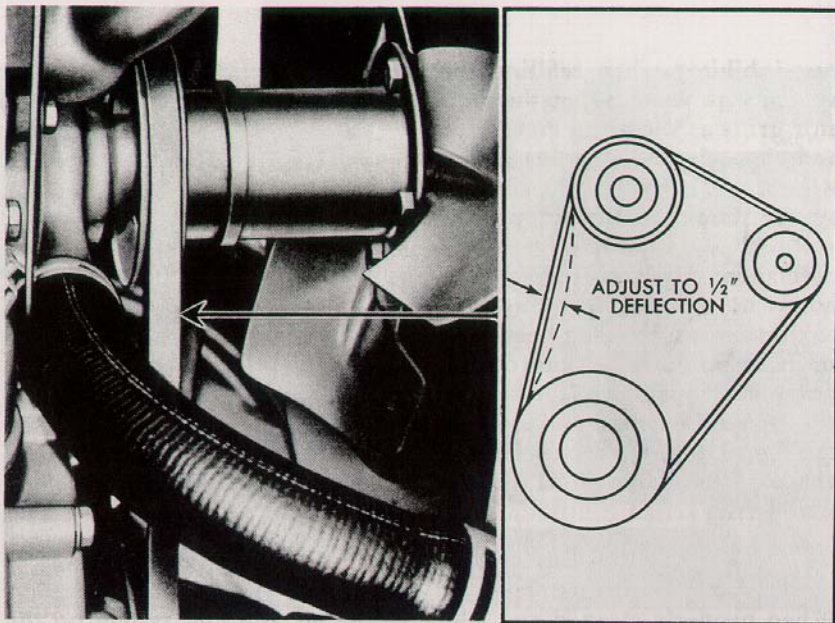

Figure 28
Adjusting Fan and Generator Belt Tension

the radiator. It should start to open at 157 to 162 degrees and be fully open at 177 to 182 degrees. If the thermostat does not function properly, it should be replaced.

Water Pump and Fan Belt: The water pump is driven by the fan belt. Check the belt periodically for proper tightness. Adjust the tension by loosening the two generator pivot bolts and the belt tension adjusting bolt. Move the generator away from the engine until a $\frac{1}{2}$ inch belt deflection is obtained with normal thumb pressure as shown in Figure 28.

Power Steering Pump Drive Belt: The power steering pump is driven by a belt from the crankshaft pulley. Check this belt periodically for proper tightness. Adjust the belt tension by tightening or loosening the turnbuckle, located between the top of the fuel tank bracket and the pump body, until a $\frac{1}{2}$ inch deflection is obtained with normal thumb pressure at belt center.

Cleaning and Protection: The cooling system should be drained, flushed and refilled with clean, soft water every spring. Remove the thermostat prior to the flushing operation. Drain the system by opening the petcock at the bottom of the radiator, the drain cock on the left side of the cylinder block and the radiator cap. Add a good grade of

rust inhibitor when refilling the system with water. Open the radiator grille as shown in Figure 29, and clean the radiator fins with a wire brush. In the fall, the cooling system should be drained, flushed and refilled with a good grade of permanent type anti-freeze. Alcohol is not recommended as protection against freezing because it starts to boil at 170° and during heavy duty operation, the tractor may operate at temperatures above this figure. Anti-freeze may be purchased from your local dealer.

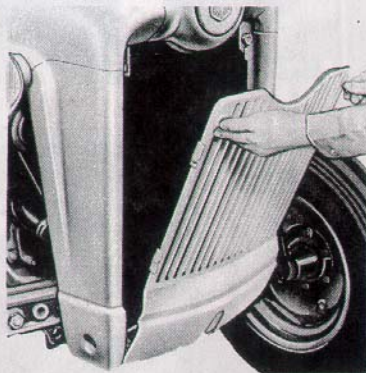

Figure 29
Opening Radiator Grille

FUEL SYSTEM

When properly cleaned and adjusted, the air and fuel system on the Ford Tractor will help provide maximum power and smooth engine performance with a minimum amount of fuel consumption.

Fuel Tank: Use only clean fuel which has been stored in a dry, cool place. At the end of each day of operation, refill the fuel tank to remove moisture laden air and reduce condensation. This is extremely important during cold weather.

Sediment Bulb: To clean the carburetor gas line sediment bulb, turn the fuel shut-off valve clockwise to the "OFF" position. Loosen the sediment bulb retaining nut, and move the retaining clamp sideways until the bowl can be removed. Remove and clean the disc screen and wipe the bowl with a clean cloth. Then replace the assembly and tighten securely. Always clean the fuel filtering screen in the sediment bulb when the bulb is cleaned. If the sediment bulb quickly accumulates an excessive amount of dirt after cleaning, the fuel tank should be drained and cleaned thoroughly.

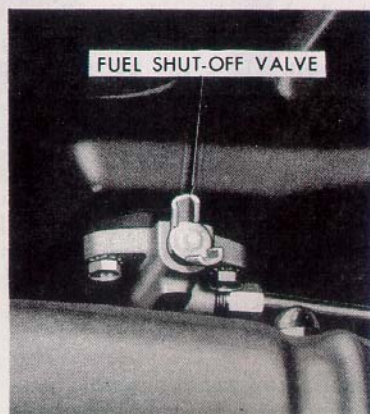

Figure 30
Fuel Shut-Off Valve Assembly

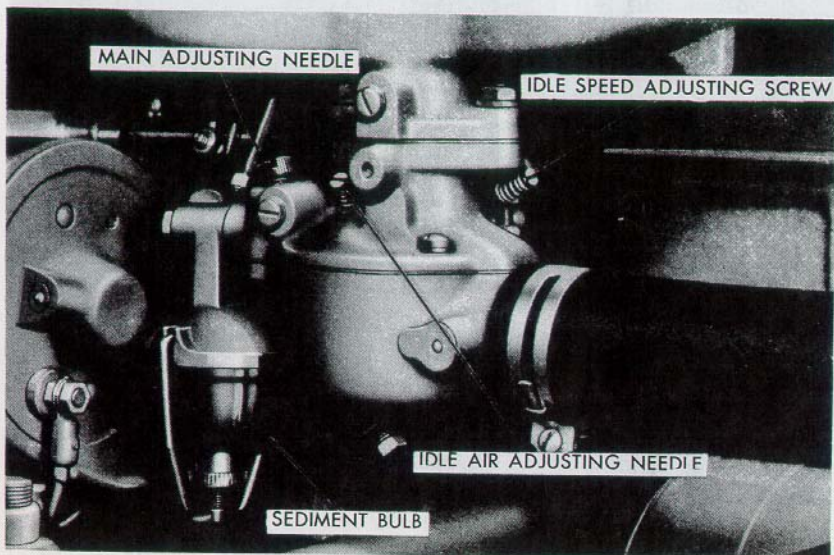

Figure 31
Adjusting the Carburetor (Series 601)

Carburetor: (Series 601) Three adjustments are provided on the carburetor. Before attempting to adjust the carburetor, however, the engine must be operated at normal temperature as shown on the gauge.

***Idle Speed Adjustment Stop Screw:** With the hand throttle in the closed position, turn the stop screw on the engine side of the carburetor until the engine idle speed is 450 to 475 R.P.M. on the Proof-Meter. On an engine that is not yet broken in, it may be necessary to set the idle speed higher to keep the engine from stalling at idle speeds.

Idle Air Adjustment Needle: For the initial setting, before the engine is started, turn the idle adjustment needle clockwise until it just seats, then back it off approximately one turn. Start the engine and turn the idle adjustment needle "IN" (clockwise) until the engine begins to "roll" from too rich a mixture, then back the needle off until the engine runs smoothly.

Main Adjusting Needle: The initial setting for the main adjusting needle is $1\frac{1}{8}$ turns open (counter-clockwise). The final adjustment should be made in the field. With the engine running at governed speed under full load, turn the adjustment needle "IN" (clockwise) until the engine power just begins to drop off, then turn the screw "OUT" until the power picks up and the engine runs smoothly.

*Maximum speed adjustment is fully outlined on page 47.

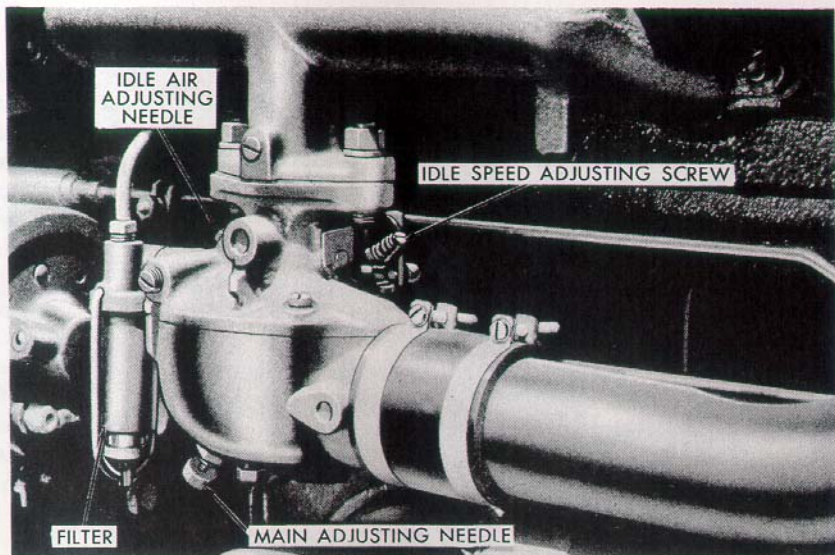

Figure 32
Adjusting the Carburetor (Series 801)

Carburetor: (Series 801) Three adjustments are provided on the carburetor. Before attempting to adjust the carburetor, however, the engine must be operated at normal temperature as shown on the gauge.

Idle Speed Adjustment Stop Screw: With the hand throttle in the closed position, turn the stop screw on the engine side of the carburetor until the engine idle speed is 450 to 475 R.P.M. as indicated on the Proof-Meter. On an engine that is not yet broken in, it may be necessary to set the idle speed higher to keep the engine from stalling at idle speeds.

Idle Air Adjustment Needle: For the initial setting, before the engine is started, turn the idle adjustment needle clockwise until it just seats, then back it off approximately one turn. Start the engine and turn the idle adjustment needle "IN" (clockwise) until the engine begins to "roll" from too rich a mixture, then back the needle off until the engine runs smoothly. It may be necessary to readjust the idle speed.

Main Adjusting Needle: The initial setting for the main adjusting needle is $2\frac{1}{8}$ turns open (counter-clockwise). The final adjustment should be made in the field. With the engine running at governed speed under full load, turn the adjustment needle "IN" (clockwise) until the engine power begins to drop off, then turn the screw "OUT" until the power picks up and the engine runs smoothly.

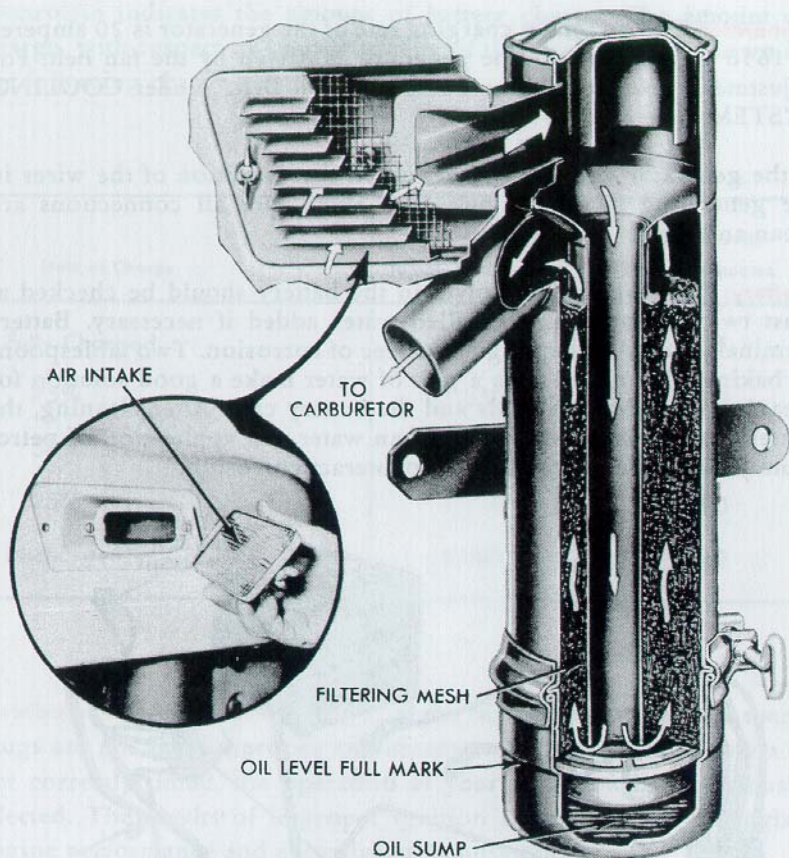

Figure 33
Sectional View of Carburetor Air Cleaner (Series 601)

Carburetor Air Cleaner: Regular service of the oil bath type air cleaner is extremely important in prolonging the engine life of your tractor. See the section on LUBRICATION, under Service Daily or Every Ten Hours, for proper servicing of the air cleaner. Figure 33 shows the passage of air through the intake screen, oil bath, filtering mesh and to the carburetor.

The installation of any accessory designed to further the filtering process serves no useful purpose and may result in increased fuel consumption and poor engine performance.

ELECTRICAL SYSTEM

Generator: The maximum charging rate of the generator is 20 amperes at 1650 engine R.P.M. The generator is driven by the fan belt. For adjustment, refer to "Water Pump and Fan Belt," under COOLING SYSTEM, page 37.

If the generator will not charge, check the condition of the wires in the generating circuit (Figure 34). Make sure all connections are clean and tight.

Battery: The level of electrolyte in the battery should be checked at least twice monthly and distilled water added if necessary. Battery terminals should be kept tight and free of corrosion. Two tablespoons of baking soda mixed with a pint of water make a good solution for cleaning corroded terminals and the battery case. After cleaning, the battery should be washed with clean water. An application of petroleum jelly on the terminals will counteract corrosion.

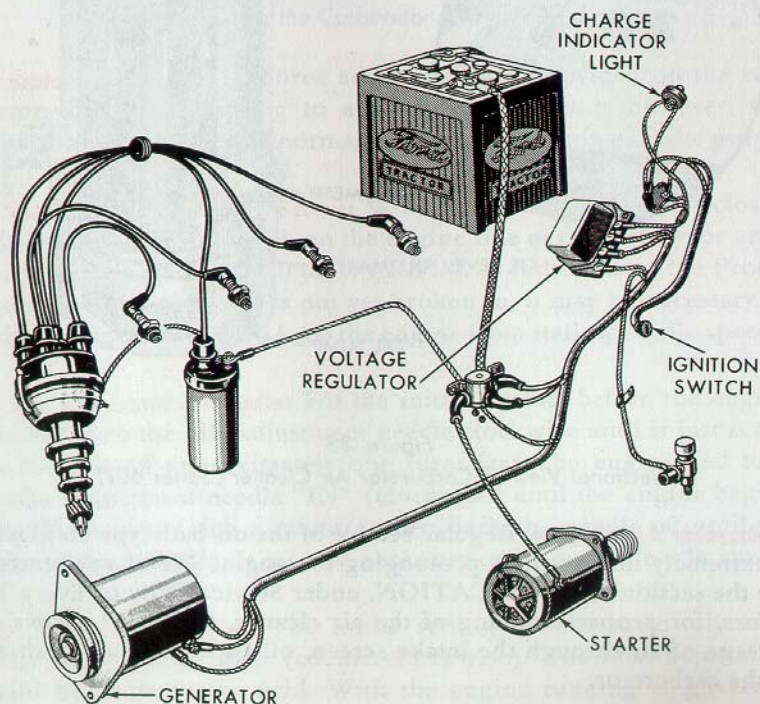

Figure 34
Generating System

Keep the battery fully charged at all times. The specific gravity of the electrolyte indicates the amount of battery charge. The amount of charge, with respect to specific gravity of the electrolyte, is shown in the following chart.

State of Charge	Specific Gravity Temperate Climates	Specific Gravity Tropical Climates
Fully Charged	1.280	1.225
75%	1.230	1.180
50%	1.180	1.135
25%	1.130	1.090
Discharged	1.080	1.040

Distributor Points and Spark Plugs: If the distributor points and spark plugs are not kept in proper adjustment and if the ignition system is not correctly timed, the operation of your tractor will be seriously affected. The results of improper ignition maintenance are sluggish engine performance and excessive fuel consumption.

Under normal operating conditions, the spark plugs should be removed, cleaned and inspected after 150 hours and replaced every 300 hours. Spark plug cleaning should be performed with a sand blast type cleaner. Spark plugs which are cracked or have excessively burned electrodes should be replaced. The proper spark plug gap is 0.025 to 0.028 inch. To set the gap, use a standard round feeler gauge as shown in Figure 35.

Proper maintenance of distributor points is of the utmost importance. Cleaning of the points, replacing when excessively worn, and the proper spacing are essential for peak efficiency.

To adjust the distributor points, remove the distributor cap. Crank the engine until the breaker arm rubbing block (see Figure 36) is resting on a high point of the distributor cam. Loosen the point assembly lock screws. Insert an adjusting tool or screwdriver in the adjustment slot and move the point assembly until the proper gap is established. The point spacing is 0.024 to 0.026 inch. Tighten the point assembly lock screws after making the adjustment.

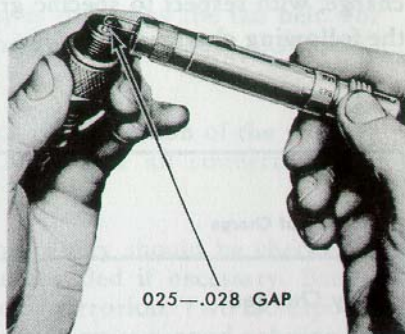

Figure 35
Checking Spark Plug Gap

To replace the points, remove the distributor cap. Remove the point assembly lock screws (Figure 36). Disconnect the condenser and primary lead, then lift the point assembly off the breaker plate. When installing new points, make certain the ground wire is properly installed under the lock screw.

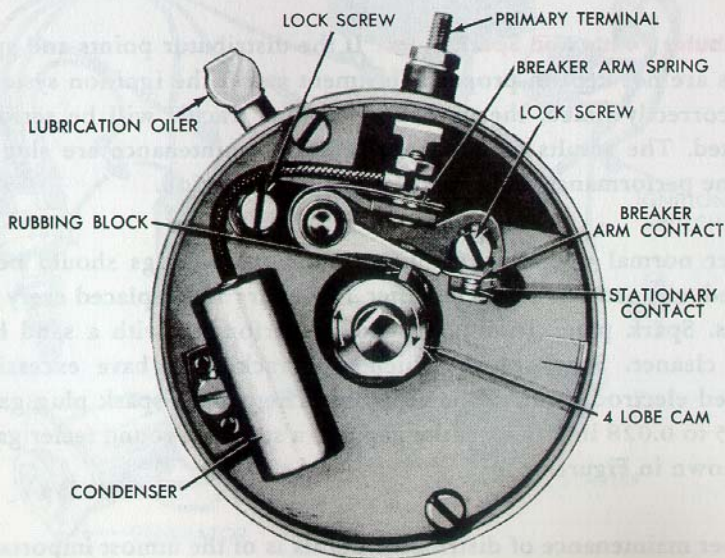

Figure 36
Distributor Assembly

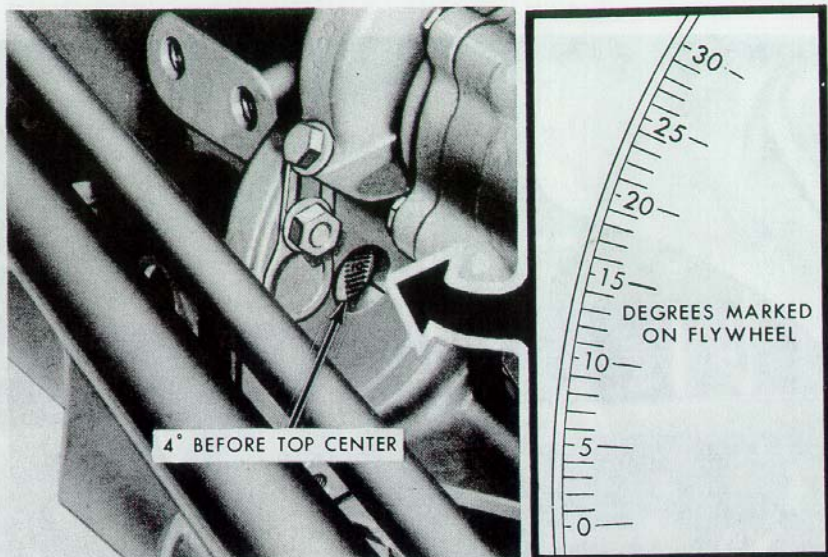

Figure 37
Basic Ignition Timing

Ignition Timing: When new distributor points are installed, the ignition system should be properly timed with a timing light. Connect the timing light to the engine with the high tension lead on the No. 1 spark plug and the other two leads on the proper battery terminals. Start the engine and run it at idle speed. Direct the timing light so that it flashes through the opening in the bell housing (see Figure 37), and note the timing marks. Ignition timing should be 4° before top dead center at 450 engine R.P.M. Loosen the clamp screws, rotate the distributor slightly until this reading is obtained, then tighten the distributor body.

ENGINE

Valve Clearance: One of the most important factors governing good engine performance is that of correct valve tappet clearances. On a new tractor, correct clearances are set before the tractor leaves the factory and are checked again by your dealer at the pre-delivery inspection. It is recommended, however, that the valve clearance be checked every 250 hours of tractor operation.

To set valve clearance, run the engine until normal operating temperature is reached. Stop the engine, shut off the fuel supply, and remove the rocker shaft cover. Tappets can only be adjusted properly

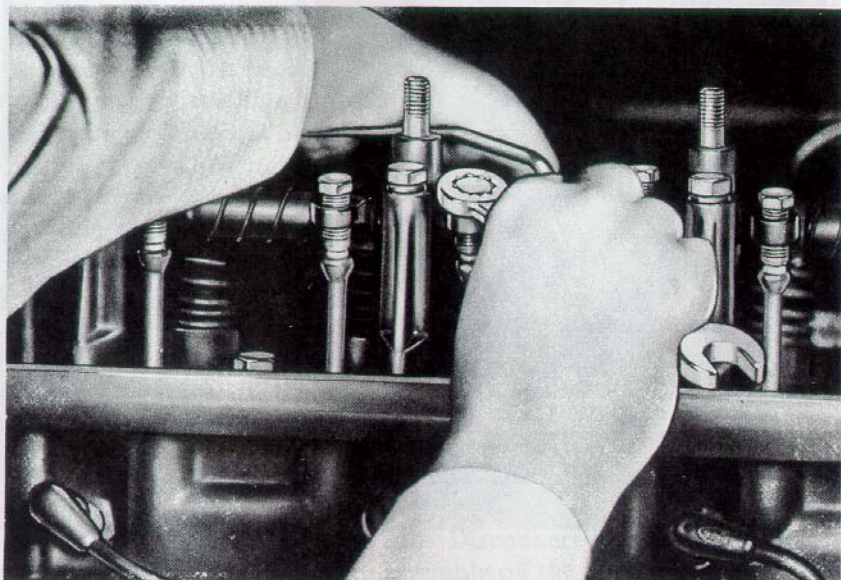

Figure 38
Valve Tappet Adjustment

when the valve is fully closed. It may be necessary to crank the engine with the starter to allow valves to close when making adjustments.

To adjust the tappets, turn the valve rocker arm adjusting screw in the desired direction as shown in Figure 38. The correct valve tappet clearance is .014 to .016 inch with the engine hot.

Valve Grinding: One of the factors involving good engine performance is absolute sealing of the combustion chamber by the valves and rings against compression losses. Valves and valve seats of modern engines are so hard that it is impossible to obtain a satisfactory valve reconditioning job by hand grinding. A good valve job is so important to engine performance that we recommend having your dealer perform this work whenever it becomes necessary.

Engine Tune-up: Engine tune-up procedure is intended to restore the engine to normal operating condition, providing excessive wear has not occurred. It is one of the most important maintenance services in that it determines whether or not the engine will perform with maximum economy and efficiency. Your dealer is best equipped to perform this service and advise as to the repairs or services necessary to restore the original performance of your tractor.

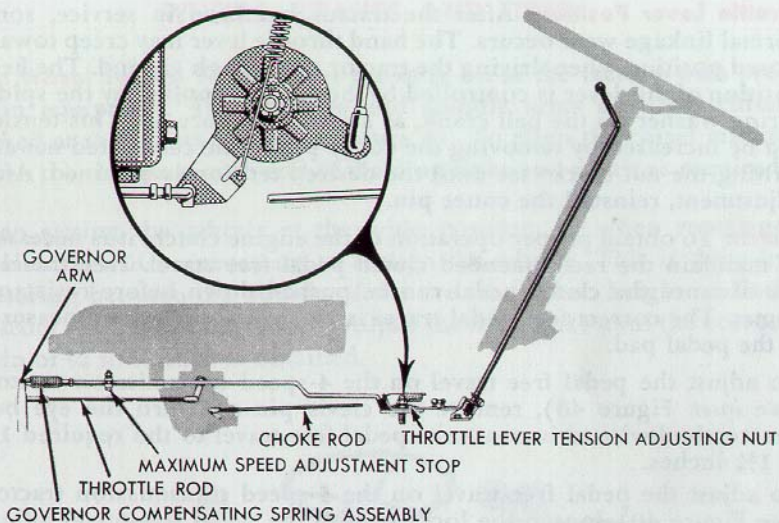

Figure 39
Governor and Control Linkage

Governor: Constant engine speed for any given throttle setting is controlled by the action of the adjustable centrifugal governor, located on the forward end of the crankshaft. As the engine speed is increased, the action of the governor moves the governor arm (see Figure 39) toward the closed carburetor throttle position until a balance between the spring tension and governor action is obtained. Maximum engine speed is controlled by the adjustable stop on the throttle rod, as shown. Before attempting to set the engine governed speed, make certain the governor lever and carburetor throttle lever are both in the full open position. This can be checked by removing the throttle rod at the carburetor, and holding the throttle lever in open position as a light pulling force is applied to the throttle rod connected to the governor speed control arm. If the throttle rod connection will not slip over the ball on the carburetor throttle arm without moving the arm, the linkage must be adjusted. To do this, loosen the clevis lock nut and change the length of the rod as required.

Maximum governed engine speed must be set under no load conditions. After the tractor engine has been warmed up, set the idle speed at 450 revolutions per minute, then open the hand throttle to the wide open position. If the Proof-Meter registers 2200 R.P.M. on 600 series tractors and 2400 R.P.M. on 800 series tractors, the governor is properly set. If adjustment is necessary, reposition the maximum speed adjustment stop as required.

Throttle Lever Position: After the tractor has been in service, some normal linkage wear occurs. The hand throttle lever may creep toward closed position when driving the tractor over rough ground. The fixed position of this lever is controlled by the tension applied by the spider spring washer on the bell crank, as shown in Figure 39. This tension can be increased by removing the cotter pin in the castellated nut and turning the nut clockwise until the desired tension is obtained. After adjustment, reinstall the cotter pin.

Clutch: To obtain proper operation of the engine clutch, it is necessary to maintain the recommended clutch pedal free travel. Free travel is the distance the clutch pedal can be pushed down before resistance is met. The correct free pedal travel is $1\frac{1}{2}$ to $1\frac{3}{4}$ inches, as measured at the pedal pad.

To adjust the pedal free travel on the 4-speed transmission tractors (see *inset*, Figure 40), remove the clevis pin and turn the eye bolt counterclockwise to increase the pedal free travel to the required $1\frac{1}{2}$ to $1\frac{3}{4}$ inches.

To adjust the pedal free travel on the 5-speed transmission tractors (see Figure 40), loosen the locknut, turn the pedal free travel adjusting screw until the $1\frac{1}{2}$ to $1\frac{3}{4}$ inches free travel is obtained, then retighten the locknut securely.

On 5-speed transmission tractors, which incorporate the single clutch, the clutch pedal should be set 7 inches (vertically) above the running board.

On Model 661 and 861 tractors, which incorporate the double clutch for live P.T.O. operation, the pedal is normally set $9\frac{3}{8}$ inches (vertically) above the running board. However, the pedal can be set for operation of the transmission clutch only, by repositioning the clevis pin in the front hole of the clevis. See Figure 40.

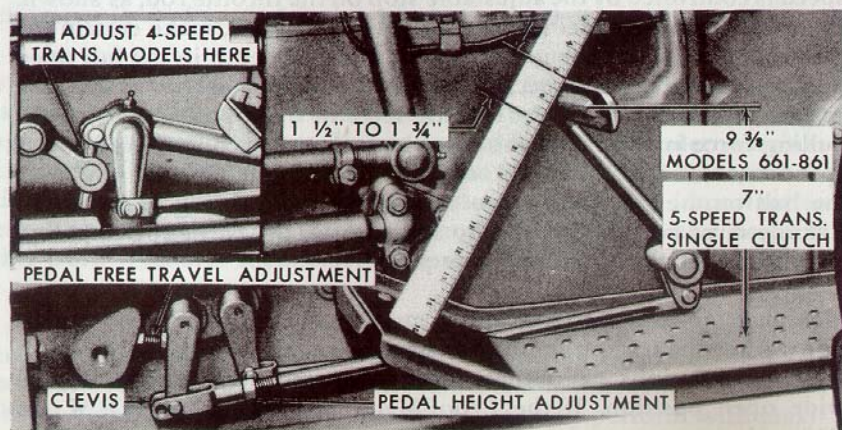

Figure 40
Clutch Pedal Free Travel Adjustment

WHEELS, BRAKES AND TIRES

Front Wheel Toe-in: Front wheel toe-in is set at the factory with precision equipment. The spindles and spindle arms are then chisel marked at the points shown in Figure 41. To align the chisel marks, loosen the clamps at each end of the drag links and adjust as required.

When setting the wheels at the wide position, or when replacing spindles, it will be necessary to realign the wheels. This is done by measuring between the outside of the tire ribs at hub height on both the front and rear of the wheels. Adjust the drag links until the correct toe-in of $\frac{1}{4}$ to $\frac{1}{2}$ inch is obtained.

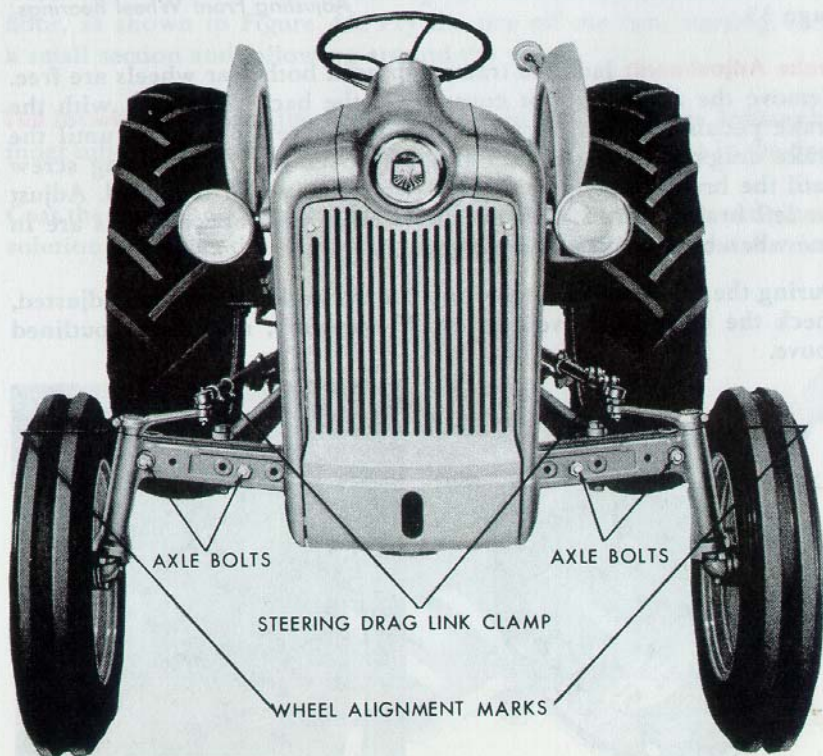

Figure 41
Front Wheel Toe-in Adjustment

Front Wheel Bearings: To adjust the front wheel bearings, raise the front of the tractor with your tractor jack until the wheels rotate freely. Remove the hub cap and the cotter pin which holds the castellated nut and turn the nut until a slight drag is felt. Then back off the nut until the nearest slot in the nut is aligned with the hole in the spindle. Reinstall the cotter pin and hub cap. Pack the bearings with short fibre grease every 600 hours of operation as directed under LUBRICATION, page 33.

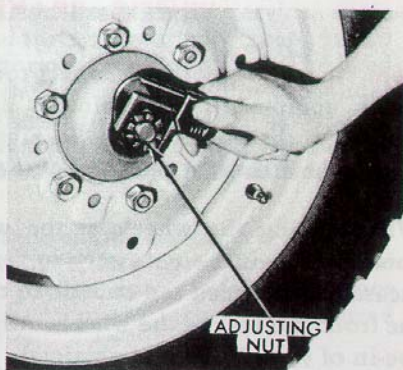

Figure 22
Adjusting Front Wheel Bearings

Brake Adjustment: Jack the tractor up until both rear wheels are free. Remove the adjusting slot cover from the back plate and, with the brake pedals released, turn the adjusting screw clockwise until the brake drags. (See Figures 43 and 44.) Back off the adjusting screw until the brake drags very slightly when the wheel is turned. Adjust the left brake tie rod with the clevis until both brake pedals are in line when both brakes are engaged.

During the first hour of operation after the brakes have been adjusted, check the drums for overheating. If necessary, readjust as outlined above.

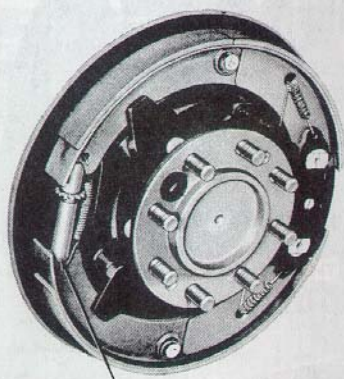

Figure 43
Brake Assembly with Drum Removed

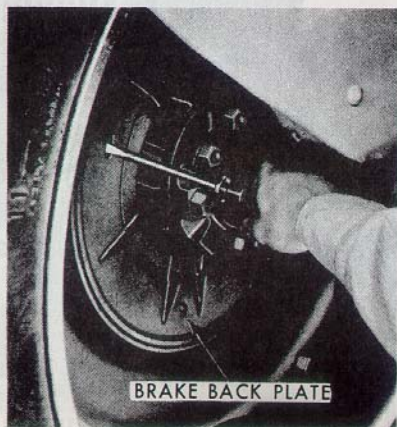

Figure 44
Adjusting the Brakes

Tire Removal: Remove the wheel from the hub and deflate the inner tube completely. Press the valve through the valve hole and loosen both tire beads from the wheel rim, using a tire iron and heavy mallet. With the wheel lying flat, stand on the tire with your feet about 15 inches apart opposite the valve, then force the bead seat into the drop center of the rim.

Insert two tire irons, about 8 inches apart, between the tire bead and the wheel rim near the valve, then pry the bead over the wheel rim. Leaving one tire iron in position, follow around the wheel rim with the other tire iron to remove the remainder of the bead. Remove the inner tube.

Turn the wheel over and block up the disc until the rim is off the floor, as shown in Figure 46. Pry the tire off the rim, starting with a small section and following around the wheel.

Tire Installation: Place the wheel and rim in a flat position. Inflate the inner tube until it is barely rounded out, then install the tube in the tire.

Coat the inside and outside of the tire beads with a soft soap and water solution to protect the bead, then pry the bead over the edge of the rim.

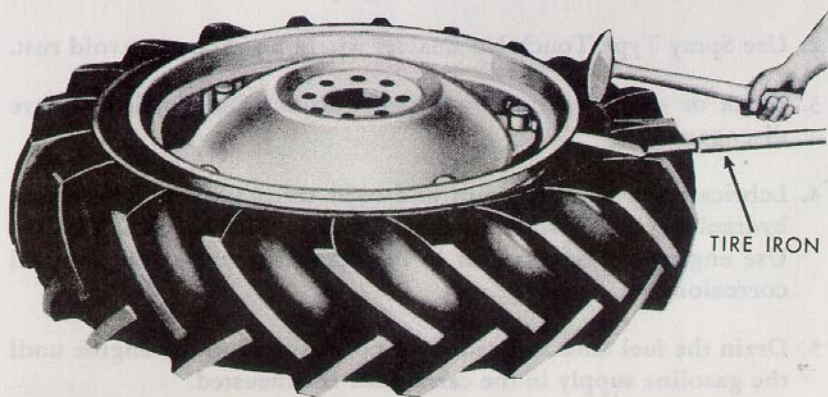

Figure 45

Loosening Tire Bead from Edge of Rim

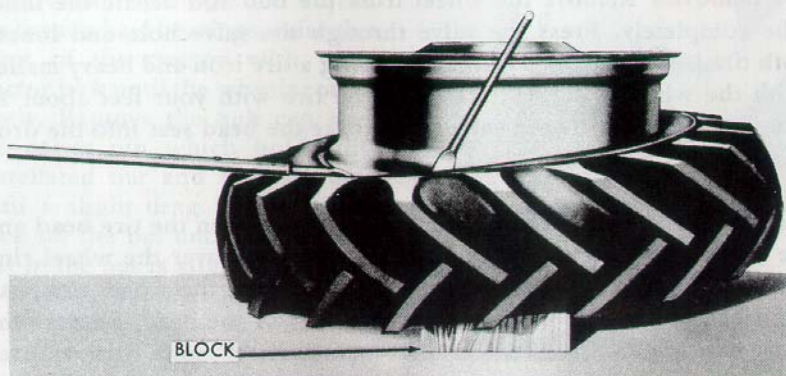

Figure 46
Prying Rim Out of Tire

TRACTOR STORAGE

Tractors which are used seasonally should be protected while in storage.

The following operations are suggested:

1. Wash and clean the tractor thoroughly.
2. Use Spray Type Touch-Up Enamel where necessary to avoid rust.
3. Block or tie down the clutch pedal so that the clutch faces are disengaged.
4. Lubricate the tractor, drain and refill transmission, differential, hydraulic system, and engine, as directed under LUBRICATION. Use engine preservative oil in the crankcase to prevent internal corrosion.
5. Drain the fuel tank and sediment bowl, then run the engine until the gasoline supply in the carburetor is exhausted.
6. Remove the spark plugs and pour three ounces of engine preservative oil into each cylinder. Turn the engine several revolutions with the starter, then replace the spark plugs. This will coat the combustion chamber with an oil film.

7. Remove the battery and be sure it is fully charged before placing it in storage in a warm place.
8. Place blocking under the tractor axles to remove the weight from the tires.
9. Open drain cocks at bottom of radiator and on left side of engine block to drain the cooling system.
10. Check the tractor for worn or damaged parts. Replace with genuine Ford Tractor parts.

Tractors which have been placed in storage should be completely serviced in the following manner before putting into use.

1. Inflate the tires to recommended pressure; fill cooling system (use corrosion inhibitor in warm weather, anti-freeze in winter), fill gasoline tank with fuel; check oil level in crankcase, rear end, transmission, and air cleaner, and install fully charged battery.
2. Start the engine and let it idle a few minutes. Be sure the engine is receiving lubrication and that each control is functioning correctly.
3. Drive the tractor without a load to be sure it is operating satisfactorily.

1. Remove the battery and be sure it is fully charged before placing it in storage in a warm place.

2. Place blocks under the tractor to remove the weight from the tires.

3. Lay the tractor on its side on the left side of engine.

4. Wash the tractor with water and soap.

5. Tractor which have been placed in storage should be completely serviced in the following manner before putting into use.

1. Install the lines to recommended pressure in cooling system (use corrosion inhibitor in warm weather and freeze in winter), fill gasoline tank with the best oil, change oil in crankcase, first and transmission, and air cleaner, and install fully charged battery.

2. Start the engine and let it idle a few minutes. Be sure the engine is receiving lubrication and that each control is functioning correctly.

3. Drive the tractor without a load to be sure it is operating satisfactorily.

4. Use Spray Type Touch-Up enamel where necessary to avoid rust.

5. Block up the down the clutch pedal so that the clutch lever can be disengaged.

6. Lubricate the tractor with good quality oil. Check the hydraulic system, as well as the engine oil.

7. Drain the fuel tank and sump, bowl, then run the engine until the gas tank is empty in the carburetor it is exhausted.

8. Remove the spark plugs and pour three ounces of engine oil into each cylinder. Turn the engine over several revolutions with the water pump. Replace the spark plugs and pour the recommended amount of oil into the cylinder.

ACCESSORIES

A wide variety of accessories, attachments and special items are available for use on your new Ford Tractor.

These are designed to make your work easier by providing you with maximum convenience and operating comfort. In many cases, they will improve the performance of your Ford Tractor and Equipment. All of the accessories, attachments and special items listed in this section are available at extra cost from your Ford Tractor and Implement Dealer. For a more detailed description of these items, see your "Ford Tractor Accessories" Booklet included in your Owner's envelope.



Be safe, be seen, use lights at night.

FORD TRACTOR ACCESSORIES AND SPECIAL ITEMS

SERIES 601 and 801

TRACTOR ACCESSORIES

- Bumper Assembly (Push or Pull Type)
- Dry Charge Battery
- Dual Rear Wheel Kits
- Grease Gun and Bracket
- Implement Lamp Kit
- Implement Warning Lamp Kit
- Power Adjusted Rear Wheels
- PTO Belt Pulley Assembly
- PTO Shield
- Remote Control Attachments
- Rest-O-Ride Tractor Seat—*Standard on 801 Series All Purpose Tractors*
- Stabilizer Bars
- Tire Pump and Gauge
- Tractor Half Cab
- Vertical Exhaust Kit
- Wheel Weights—Rear—Heavy Duty—*For 801 Series Tractors Only*
- Wheel Weights—Rear—Regular Duty
- Wheel Weights—Front

SPECIAL ITEMS

A complete line of chemicals, hydraulic oil and oil additives plus paints are available. For further details see your Ford Tractor and Implement Dealer.

SPECIFICATIONS

The specifications on the following pages are provided for your information and reference. For further information see your local Ford Tractor and Implement Dealer.

The Ford Motor Company reserves the right to make changes in specifications or to add improvements at any time without notice or obligation.



Be Safe—be careful at all times.

SPECIFICATIONS

FORD ALL PURPOSE AND SPECIAL UTILITY TRACTORS SERIES 601 & 801

GENERAL

Wheelbase @ 52" Tread Width.....	74.5 inches
Over-all Length @ 52" Tread Width....	Series 601—120.83 inches Series 801—120.83 inches
Over-all Width @ 52" Tread Width.....	63.9 inches
Front Tread Width.....	All Purpose Tractors—52 to 76 inches
Rear Tread Width.....	All Purpose Tractors—52 to 76 inches
Front Tread Width.....	Special Utility Tractors—52 to 76 inches
Rear Tread Width.....	Special Utility Tractors—52 to 76 inches
Rear Tread Width.....	Power Adjusted Wheels—56 to 84 inches
Crop Clearance.....	21 inches (approx.)
Turning Circle Diameter (with brakes).....	17 feet 10 inches
Shipping Weight.....	Model 621—2462 lbs. Model 631—2662 lbs. Model 641—2737 lbs. Model 651—2825 lbs. Model 661—2812 lbs. Model 821—2637 lbs. Model 841—2725 lbs. Model 851—2984 lbs. Model 861—2991 lbs.

Tire Size:

Front—Standard.....	Series 601—5:50 x 16—4 ply Series 801—6:00 x 16—4 ply
Rear—Standard.....	Series 601—11:00 x 28—4 ply Series 801—12:00 x 28—4 ply
Rear—Standard (Special Utility Tractors only).....	10:00 x 28—4 ply

CAPACITIES

Fuel Tank.....	Series 601—13 U.S. gallons (10.83 Imperial gals.) Series 801—17 U.S. gallons (14.16 Imperial gals.)
Cooling System.....	15 U.S. quarts (12.5 Imperial qts.)
Crankcase (including filter).....	5 U.S. quarts (4.16 Imperial qts.)
Transmission.....	4 Speed—6½ U.S. quarts (5.41 Imperial qts.) 5 Speed—8½ U.S. quarts (7.08 Imperial qts.)
Hydraulic Reservoir.....	8 U.S. quarts (6.66 Imperial qts.)
Rear Axle.....	Series 601—8 U.S. quarts (6.66 Imperial qts.) Series 801—11½ U.S. quarts (9.58 Imperial qts.)
Steering Gear Housing.....	1½ pounds

ENGINE

Type.....	4 cylinder, in-line, overhead valve
Bore.....	Series 601—3.44 inches Series 801—3.90 inches

Stroke.....	3.60 inches
Displacement.....	Series 601—134 cu. inches Series 801—172 cu. inches
Compression Ratio.....	Series 601—7.5 to 1 Series 801—7.5 to 1
Firing Order.....	1-2-4-3
Idle Speed.....	450 R.P.M.
Maximum Speed (no load).....	Series 601—2200 R.P.M. Series 801—2400 R.P.M.
Sleeves.....	Cast iron, dry type
Pistons.....	Aluminum alloy
Tappet Clearance (intake and exhaust—hot).....	.014 to .016 inch
Governor.....	Variable speed, centrifugal flyball type

COOLING SYSTEM

Type.....	Pressure
Fan.....	Three blade
Thermostat.....	Starts to open—157 to 162° F. Fully open—177 to 182° F.

FUEL SYSTEM

Type.....	Gravity flow
Carburetor.....	Single up-draft
Idle Fuel Adjustment.....	One turn—open
Main Fuel Jet Adjustment.....	Series 601—One and one-eighth turns Series 801—Two and one-eighth turns

IGNITION SYSTEM

2-1/8 SHOULD READ 1-1/4 TURNS

Type.....	Dist.—automatic centrifugal spark advance
Initial Timing.....	4 degrees B.T.D.C. at 450 R.P.M.
Advance at 2000 R.P.M.....	25 to 27 degrees
Distributor Point Spacing.....	.024 to .026
Spark Plug Size (H-10).....	14 MM
Spark Plug Gap.....	.025—.028

ELECTRICAL SYSTEM

Generator.....	Two brush shunt wound
Capacity.....	20 amps., 140 watts
Generator Regulator.....	Relay type
Battery.....	6 volt—80 ampere hours
Terminal Grounded.....	Positive
Starter Motor.....	Automatic, with safety switch 6 volt—follow through

CLUTCH

Type.....	Models 621, 631 and 641—Single plate, 10 inch Model 651—Single plate, 10 inch Model 661—Double plate, 9 inch Models 821, 841 and 851—Single plate, 10 inch Model 861—Double plate, 9 inch
Pedal free travel.....	1½ to 1¾ inches

TRANSMISSION

Type.....Models 621, 631, 641 and 841
Constant mesh, 4 speed, helical gear

Gear Ratios:

First Gear.....11.00 to 1
Second Gear..... 8.56 to 1
Third Gear..... 6.22 to 1
Fourth Gear..... 2.98 to 1
Reverse Gear..... 10.04 to 1

Type.....Models 651, 661, 821, 851, 861—
Constant mesh, 5 speed, helical gear

Gear Ratios:

First Gear.....17.55 to 1
Second Gear.....11.04 to 1
Third Gear..... 8.31 to 1
Fourth Gear..... 6.02 to 1
Fifth Gear..... 3.38 to 1
Reverse Gear.....10.29 to 1

HYDRAULIC SYSTEM

Type.....Live action
Maximum Pressure.....2000 lbs. p.s.i.

Pump:

Type.....Piston
Drive.....Gear
Capacity.....4 G.P.M. at 2000 R.P.M. (Engine)

Control (Selective).....Implement position or constant draft

POWER STEERING SYSTEM

Type.....External Linkage
Maximum Pressure.....800 p.s.i.

Pump:

Type.....Piston
Drive.....Belt
Capacity.....4.75 to 5.25 G.P.M. at 1250 R.P.M.

Cylinder.....2 Twelve Inch Stroke Booster Cylinders
Steering Gear.....Integral Steering Gear and Valve

REAR AXLE

Type.....Semi-floating
Ratio.....Series 601—6.67 to 1
Series 801—7.17 to 1

BRAKES

Type.....Internal expanding
Control.....Mechanical
Width.....1½ inch
Drum Size.....14-inch diameter
Pedal Free Travel.....¾ inch

AMERICAN PETROLEUM INSTITUTE OIL CLASSIFICATION

NEW TYPE	WHEN TO USE	OLD TYPE
ML ...	Light and Favorable Conditions:.....	Regular
	Light or normal operation. This includes average loads with no severe high or low temperature conditions. (Not recommended for Tractor use.)	
MM ...	Moderate to Severe Conditions:.....	Premium
	Moderate to severe operation. This includes heavy loads and most temperature conditions.	
MS ...	Unfavorable or Severe Conditions:.....	Heavy Duty
	This type of operation includes the most severe loads and temperature variation. Operation during winter months promotes condensation, oil dilution and sludge formation. High temperature, heavy-load service promotes oxidation of the lubrication oil and may cause high-temperature varnish and sludge deposits.	

CONTENTS

PAGE

STANDARD AND OPTIONAL EQUIPMENT CHART.....	2
FOREWORD.....	3
TRACTOR MODEL AND SERIAL NUMBER.....	4
CONTROLS AND INSTRUMENTS.....	5
Tractor Seat.....	6
Light Switch.....	6
Ignition Switch.....	6
Choke Control.....	7
Gear Shift Lever.....	7
Starter Button.....	7
Throttle Control.....	7
Oil Pressure Gauge.....	7
Temperature Gauge.....	8
Fuel Gauge.....	8
Charge Indicator Light.....	8
Clutch Pedal.....	8
Brake Pedals.....	9
Brake Pedal Locks.....	9
Power Take-Off Lever.....	9
Hydraulic Touch Control Lever.....	9
Selector Lever.....	10
Fuel Shut-Off Valve.....	10
Proof-Meter.....	10
OPERATION.....	13
Pre-Starting Check.....	14
Fuel.....	14
Break-In Procedure.....	14
Starting the Engine.....	15
Operating the Tractor.....	15
Operating the Hydraulic System.....	16
Implement Position Control.....	16
Constant Draft Control.....	17
Hydraulic Piston Pump.....	17
Attaching Implements.....	18
Two Hole Hydraulic Lift Rocker.....	18
Adjustable Top Link.....	19
Swinging Drawbar.....	19

	PAGE
Power Take-Off Operation.....	20
Power Take-Off Shaft.....	21
Belt Pulley.....	21
Wheel Tread Adjustments.....	22
Front Wheel Tread Adjustments.....	22
Rear Wheel Tread Adjustments.....	23
Power Adjusted Rear Wheels.....	24
Wheel Weight.....	26
MAINTENANCE.....	29
Pre-Delivery Inspection.....	30
50 Hour Inspection.....	30
Lubrication.....	30
Service Daily or Every Ten Hours.....	30
Service Every 100 Hours.....	32
Service Every 200 Hours.....	33
Service Every 600 Hours.....	33
Lubrication Chart.....	34, 35
Mechanical Maintenance.....	36
Cooling System.....	36
Fuel System.....	38
Electrical System.....	42
Engine.....	45
Wheels, Brakes and Tires.....	49
Tractor Storage.....	52
ACCESSORIES.....	55
SPECIFICATIONS.....	57
General.....	58
Capacities.....	58
Engine.....	58
Cooling System.....	59
Fuel System.....	59
Ignition System.....	59
Electrical System.....	59
Clutch.....	59
Transmission.....	59
Hydraulic System.....	60
Rear Axle.....	60
Brakes.....	60
American Petroleum Institute Oil Classification.....	61

NOTES

**SEE THIS GREAT LINE OF FORD AND DEARBORN
IMPLEMENTS ENGINEERED FOR THE FORD TRACTORS**

DISC PLOWS

DISC TILLERS

FIELD CULTIVATORS

MIDDLEBUSTERS

MOLDBOARD PLOWS

ONE-WAY PLOWS

SUBSOILERS

BUSH & BOG HARROWS

FOLD-OVER HARROWS

SPRING TOOTH HARROWS

TANDEM DISC HARROWS

CORN PLANTERS

CORN & COTTON PLANTERS

GRAIN DRILLS

ROTARY HOES

ROW CROP CULTIVATORS

SIDE DRESSERS

HAY BALERS

COMBINES

CORN HARVESTERS

CORN PICKERS

FORAGE HARVESTERS

MOWERS

SIDE DELIVERY RAKES

BLADES

CRANES

FRONT & REAR LOADERS

SCOOPS

LIME & FERTILIZER SPREADERS

MANURE SPREADERS

WAGONS

CORDWOOD SAWS

DRIVER & BREAKERS

POST HOLE DIGGERS

ROTARY CUTTERS

ELEVATORS



