

FORD TRACTOR

DIESEL

861

601 D AND 801 D
SERIES



OWNER'S

MANUAL

Prepared by
TRACTOR AND IMPLEMENT DIVISION
FORD MOTOR COMPANY

Tractor Service Policy

AUTHORIZED	
	
TRACTOR	
AND IMPLEMENT DEALER'S	
SERVICE POLICY	
OWNER'S NAME _____	
MAILING ADDRESS _____	
CITY _____	STATE _____
TRACTOR MODEL _____	
SERIAL NUMBER _____	
DELIVERY DATE _____	
ISSUED BY: _____	
FORD TRACTOR AND IMPLEMENT DEALER	
CITY _____	STATE _____
<small>This Tractor Service Policy is valid only when issued with a new Ford Tractor or a new Fordson Major Diesel Tractor that is sold and delivered to the above-named owner by the undersigned Ford Tractor and Implement Dealer, and if signed by said owner at the time of issuance.</small>	
DEALER'S SIGNATURE _____	
OWNER'S SIGNATURE _____	

At the time of delivery of your new tractor, the Ford Tractor and Implement Dealer presented to you a copy of the Service Policy shown above. This policy certifies that your new Ford Tractor has been properly inspected and prepared for delivery by the dealer.

The policy should be presented to the dealer whenever you request any service which is authorized on it. We recommend, therefore, that you keep the policy in a safe place for ready reference at all times.

FORD TRACTOR

*All Purpose and
Special Utility Models*

SERIES 601-D AND 801-D

OWNER'S MANUAL

Copyright 1959
Ford Motor Company
All Rights Reserved

Prepared by
TRACTOR AND IMPLEMENT DIVISION
FORD MOTOR COMPANY
BIRMINGHAM, MICHIGAN

STANDARD AND OPTIONAL EQUIPMENT CHART

Model	STANDARD EQUIPMENT										OPTIONAL EQUIPMENT							
	4-Speed Trans.	Select-O-Speed Trans.	Proof-Meter	Temp. Gauge	Hyd. System	Three Point Linkage	1000 RPM PTO and Ground Speed	540 RPM PTO	Swing-ing Draw-bar	Lights	Rest-O-Ride Seat	Tools and Tool Box	Auxiliary Trans.	Power Steer.	Power Adj. Wheels	540 RPM PTO	Indus. Front End	H.D. Clutch
611-D		X							*X					X	X	**X	X	
811-D		X							*X					X	X	**X	X	
621-D	X								*X			X	X	X	X	X	X	X
821-D	X								*X			X	X	X	X	X	X	X
631-D	X				X						X	X	X	X	X	X	X	X
641-D	X		X	X	X	X		X	X		X	X	X	X	X		X	X
671-D		X	X	X	X	X		**X	X		X	X	X	X	X		X	
681-D		X	X	X	X	X	**X	**X	X		X	X	X	X	X		X	
841-D	X		X	X	X	X		X	X		X	X	X	X	X		X	X
871-D		X	X	X	X	X		**X	X		X	X	X	X	X		X	
881-D		X	X	X	X	X	**X	**X	X		X	X	X	X	X		X	

*Fixed drawbar. **Engine Speed P.T.O. Independent.

FOREWORD

We wish to congratulate you on your choice of the new Ford Diesel Tractor. We are happy to have you as a customer and are confident that you will receive unequalled performance from your Ford Tractor.

This manual has been prepared to acquaint you with the many features of your new tractor. Due to the selection of engines, transmissions, clutches and axles available with the new Ford Tractors, most of the information presented here is general and applies to both Series 601-D and 801-D tractors.

For your convenience, a Standard and Optional Equipment Chart for the "All Purpose" and "Special Utility" Tractors is provided on the opposite page. Read this manual carefully at your first opportunity and keep it in a convenient location for later reference. You will be particularly interested in the "break-in" instructions starting on Page 14, and the maintenance instructions starting on Page 33.

If, at any time, you have a question or problem concerning your new tractor, remember that your Ford Tractor and Implement Dealer is best qualified and equipped to serve your needs. With the proper treatment and service, your Ford Diesel Tractor should provide you with a long life of profitable and dependable service.



TRACTOR AND IMPLEMENT DIVISION
FORD MOTOR COMPANY
SERVICE DEPARTMENT

TRACTOR MODEL AND SERIAL NUMBER

All Purpose Ford Tractors: These tractors are identified by the model numbers 641-D, 671-D, 681-D, 841-D, 871-D and 881-D.

Special Utility Ford Tractors: These tractors are identified by the model numbers 611-D, 621-D, 631-D, 811-D and 821-D and have the same features as the other models in the corresponding series except those features which are not necessary to special utility work. Model numbers for both the ALL PURPOSE and SPECIAL UTILITY FORD TRACTORS identify the type of tractor, engine, transmission, clutch and axle. See chart on Page 2.

When ordering parts or requesting information from your Ford Tractor and Implement Dealer, always specify the Model and Serial Number of your Ford Diesel Tractor.

The Model and Serial Number is located on the left front side of the transmission housing and should be recorded immediately in the space provided below.

MODEL

SERIAL NUMBER

CONTROLS AND INSTRUMENTS

The controls on your new Ford Tractor are designed to help you do more work with the greatest possible convenience and comfort. All are within easy reach and are simple to operate.

The well-grouped instruments tell you, at a glance, whether the engine is operating efficiently and warn you of the possibility of trouble before it becomes serious.

Before attempting to start or operate your new tractor, familiarize yourself with the location and function of all controls and instruments.



*Know your controls and instruments
to assure Safe Operation.*

CONTROLS AND INSTRUMENTS

TRACTOR SEAT

Take your place in the tractor seat. If the seat is not in the most comfortable operating position, it may be moved forward or rearward as desired. The seat pan may be tilted back, permitting the operator to stand, or to protect it from dew and rain. Series 801 All Purpose tractors are equipped with a Rest-O-Ride seat which may be adjusted to accommodate the weight of individual operators.

LIGHT SWITCH

The tractor lights are operated by means of a switch on the lower right side of the instrument panel, just below the side panel. Pull the switch out to turn the lights on.

STARTER SWITCH

The starter switch is located on the lower left side of the instrument panel, just below the side panel. Turn the key clockwise to turn the switch on, and counter-clockwise to turn it off.

GEAR SHIFT LEVER

The 4-Speed Transmission gear shift lever is located directly in front of the tractor seat. See diagram of shift positions, Figure 1.

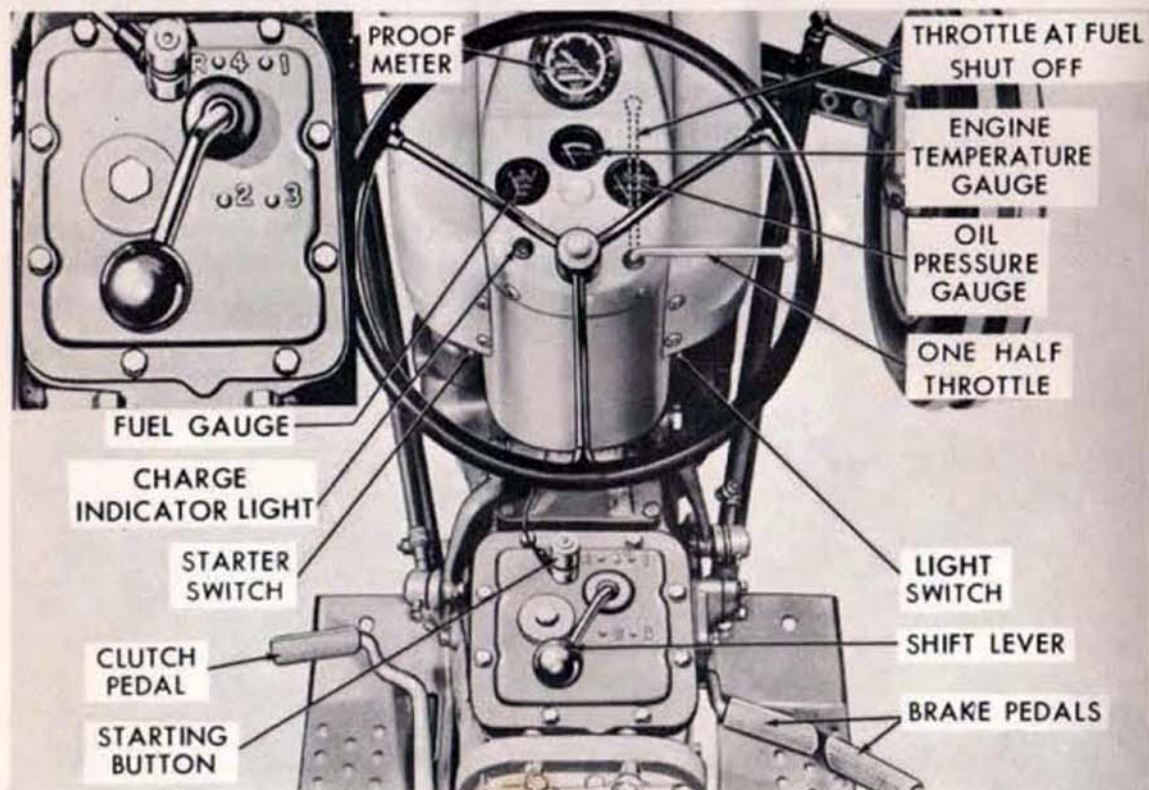

Figure 1
Controls and Instruments—4-Speed Tractor

SELECT-O-SPEED SHIFT LEVER

The Select-O-Speed Transmission shift lever is located on the speed selector housing which is directly under the steering wheel. As the lever is shifted, a selector indicator, Figure 4, shows the gear selected.

STARTER BUTTON

On 4-Speed Transmission equipped tractors, a safety type starter button is located on the top of the transmission housing within easy reach of the operator. As a safety feature, the starter button will not start the engine until the gear shift lever is placed in the neutral position.

On Select-O-Speed Transmission equipped tractors, the safety type starter button, Figure 4, is located on the underside of the hood panel. As a safety feature, the starter button will not start the engine until the shift lever is placed in the park (P) position.

THROTTLE CONTROL

The hand operated throttle control is located at the right side of the steering column. Pull the lever down to increase the engine speed.

OIL PRESSURE GAUGE

The engine oil pressure gauge indicates the oil pressure through oil passages, but does not show the amount of oil in the crankcase. Oil in the crankcase can become dangerously low and still show pressure on the gauge. Check the pressure gauge periodically during operation to be sure that the lubrication system is operating satisfactorily.

TEMPERATURE GAUGE

The engine temperature gauge at the top center of the instrument cluster registers the temperature of coolant in the cooling system. Form the habit of checking this gauge frequently. The green block indicates normal temperature, red indicates overheating and orange shows that the engine is operating at too cold a temperature.

FUEL GAUGE

The fuel gauge indicates the fuel level when the starter switch is turned on. Check this gauge frequently to make sure the fuel supply is adequate.

CHARGE INDICATOR LIGHT

The generator charge indicator light will flash on when the starter switch is turned on and while starting the engine. After the engine starts and the engine speed is increased, the light will go out. The charge indicator light flashes on if the generator is not supplying current to the battery.

TRANSMISSION LUBRICATION LIGHT

The Select-O-Speed Transmission is pressure lubricated. A lubrication light, Figure 4, indicates low oil pressure when lit.

CLUTCH PEDAL

On 4-Speed Transmission equipped tractors the foot operated clutch pedal, located on the left side of the transmission housing, must be depressed to disengage the clutch.

INCHING PEDAL

On Select-O-Speed Transmission equipped tractors a foot operated inching pedal, Figure 5, allows you to ease into implements when attaching them, and can be used for quick disengagement of power to the rear wheels.

BRAKE PEDALS

Foot operated brake pedals are provided on the right side of the transmission housing. To stop the tractor, depress both pedals simultaneously. Apply the right brake when making short right turns, and the left brake when turning left.

BRAKE PEDAL LOCKS

Brake locks, located on the right and left sides of the rear axle housing should always be set before leaving the tractor. To lock either brake, first depress the brake pedal and pull upward on the corresponding brake control rod to engage the brake pawl. To insure lock engagement, release the brake pedal slightly while holding the control rod upward. See Figures 2 and 3. To release either brake, depress the desired brake pedal sharply. This will permit the spring loaded brake control rod to disengage the brake pawl from the lock.

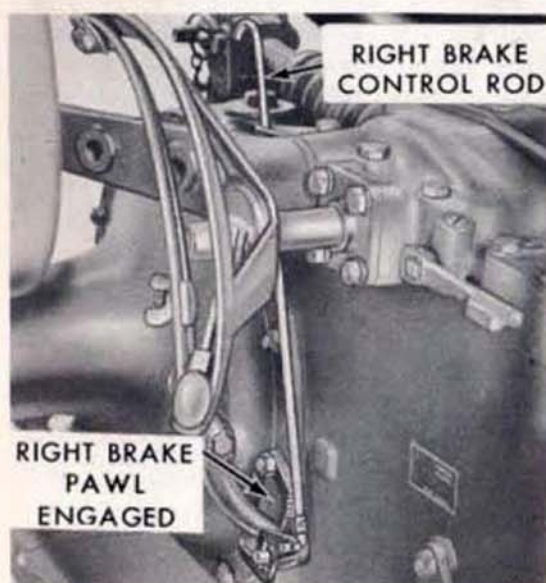

Figure 2
Brake Pawl Engaged

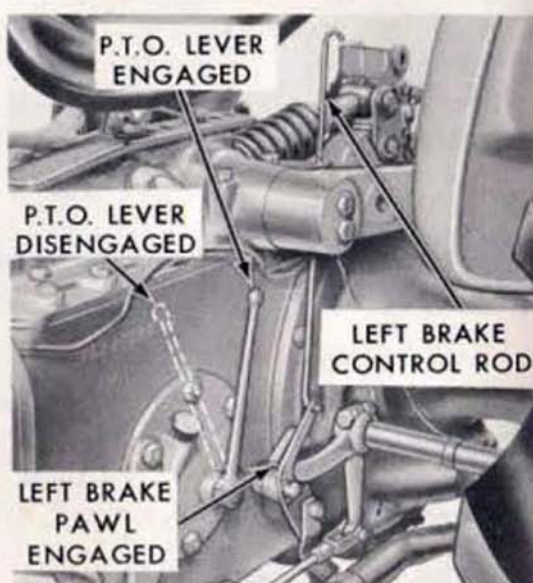

Figure 3
Power Take-Off Lever Engaged

POWER TAKE-OFF LEVER

The power take-off lever is located on the left side of the center housing. The power take-off is engaged when the lever is in the rear position (see Figure 3), and disengaged when the lever is forward. Always depress the clutch pedal when engaging or disengaging the power take-off while the tractor engine is running.

PTO CONTROL KNOB

On tractors equipped with the Select-O-Speed transmission the PTO control knob is conveniently located in front of the operator as shown in Figure 4 below. Slowly pulling the knob outward permits gradual engagement of the PTO shaft to ease into loads. To disengage the PTO at the end of the row for turning, etc., just push the knob in. Then, engage it again when you start a new row.

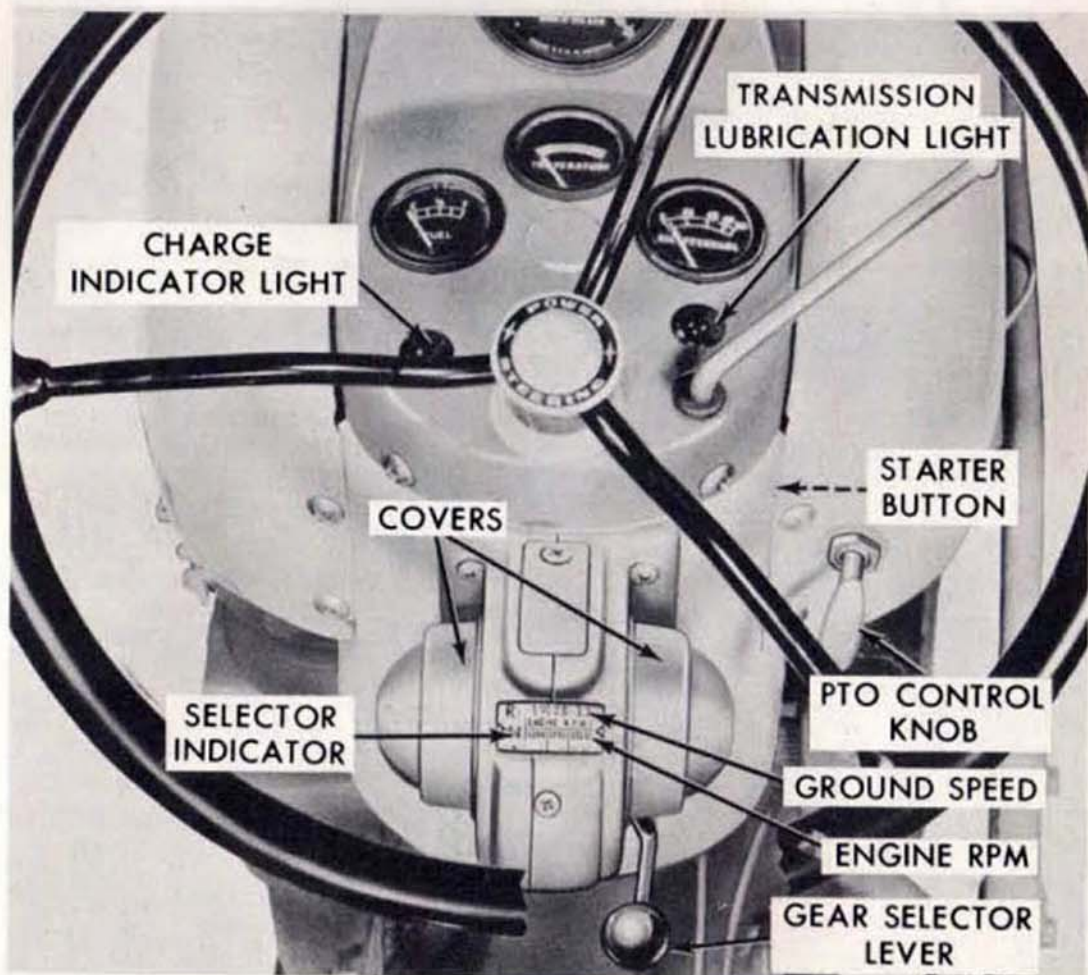

Figure 4
Controls and Instruments on the Select-O-Speed
Transmission Equipped Tractor

ENGINE PTO SPEED SHIFT LEVER

Two engine PTO speeds are available on the Model 681-D and 881-D tractors. When the PTO speed shift lever, Figure 5, is in the forward position the PTO shaft turns at the standard A.S.A.E. speed of 540 rpm. When the speed shift lever is in the rear position the shaft turns at 1000 rpm. Both PTO speeds are obtainable at 1750 engine rpm.

GROUND SPEED PTO SHIFT LEVER

The proportional ground speed PTO is available on the Model 681-D and 881-D tractors. Move the ground speed PTO shift lever, Figure 5, to the forward position to place the shaft in operation. The shift lever must be in the disengaged or "Off" position in order to pull out the PTO control knob.

DRIVE LINE DISENGAGEMENT STRAP

To tow or push a Select-O-Speed Transmission equipped tractor, when the engine is not running, the drive line must be disengaged from the rear axle. This is necessary as the Select-O-Speed Transmission shifts automatically to park (P) whenever the engine stops. Operation of the disengagement strap, Figure 5, is described on Page 19 of this manual.

HYDRAULIC SELECTOR LEVER

The selector lever under the tractor seat changes the hydraulic system

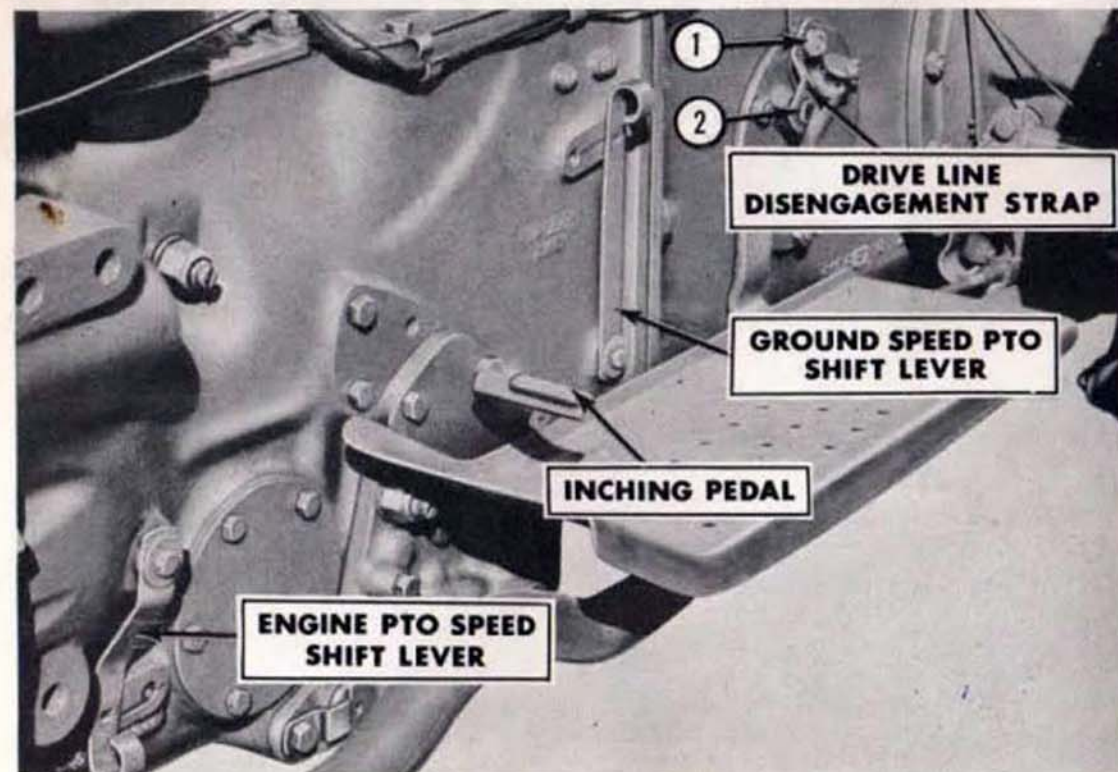

Figure 5
Select-O-Speed Transmission Controls

from constant draft to implement position control. Place the lever in the "Down" position for Constant Draft Control, and in the "Up" or horizontal position for Implement Position Control. See Figure 6.

HYDRAULIC LIFT CONTROL LEVER

The lift control lever, which controls the hydraulic system, is the large lever to the right of the tractor seat. To raise the lift arms, raise the lever to the top position. To lower the lift arms, push the lever to the lower position as shown in Figure 6.

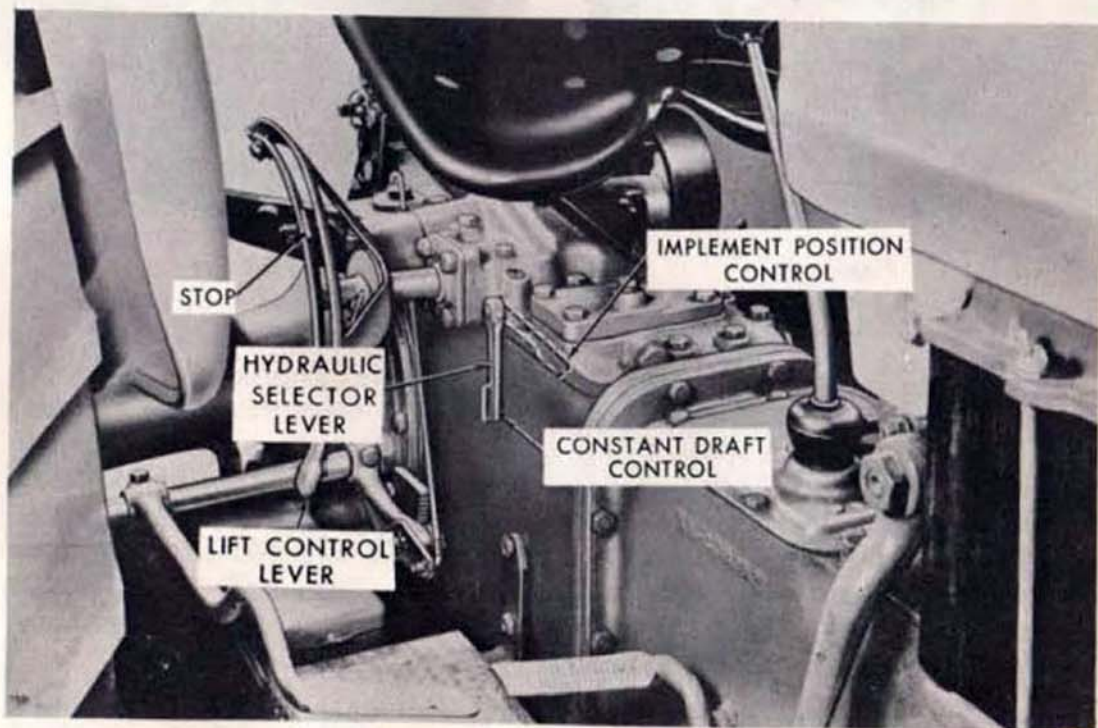

Figure 6
Hydraulic Control Levers

PROOF-METER

The Ford Tractor Proof-Meter, conveniently located at the top center of the instrument panel, is actually five instruments in one. The separate functions of the Proof-Meter are described in the following paragraphs and are illustrated in Figures 7 and 8.

Engine Speed: Engine revolutions per minute, from 0 to 2400 rpm are shown on the outer band of the Proof-Meter. Knowing the correct engine speed is helpful in checking correct oil pressure and maintaining the proper engine idle speed.

Tractor Ground Speed: The ground speed (M.P.H.) on tractors with four speed transmissions is read in the band directly under the gear number on the pointer as shown in Figure 7. On Select-O-Speed Transmission equipped tractors, the ground speed is given in 10th gear only and is read on the inner band of figures as shown in Figure 8.



Figure 7
4 Speed Proof-Meter



Figure 8
Select-O-Speed Proof-Meter

PTO Speed: The American Society of Agricultural Engineers (A.S.A.E.) standard for power take-off speed is 540 ± 10 revolutions per minute. This is shown on the 4 speed Proof-Meter at 1485 engine rpm and on the Select-O-Speed Proof-Meter at 1750 engine rpm. Most power take-off implements will operate at maximum efficiency when the proof meter pointer is held at this speed. On Model 681-D and 881-D tractors an additional PTO speed of 1000 rpm is available. This PTO speed is also indicated at 1750 engine rpm. For further information on the power take-off, refer to page 23 of this manual.

Belt Pulley: For best performance, most stationary machinery must be operated at the correct belt speed. The A.S.A.E. has established a standard range for belt speeds of from 3,000 to 3,200 feet per minute. A belt speed within this range is reached with a standard nine inch belt pulley when the Proof-Meter indicates 1750 engine rpm for the 4-speed transmission equipped tractor and 2200 engine rpm for the Select-O-Speed Transmission equipped tractor. The best speed is dependent on the size of the belt pulley and the pulley rpm. For further information on pulley sizes and belt speeds consult the chart on page 25.

CAUTION: Do not operate the belt pulley with the engine P.T.O. speed shift lever in the 1000 rpm position on Select-O-Speed Transmission equipped tractors.

Engine Hours: The hour meter portion of the Proof-Meter represents the hours your tractor engine has "worked," based on an average engine speed of 1515 revolutions per minute. Engine speeds below 1515 revolutions accumulate hours more slowly than clock hours, and those above 1515 rpm register faster than clock hours. Use this feature of the Proof-Meter to determine when service and maintenance are necessary. It will help you cut operating costs and prolong the life of your new tractor.

OPERATION

Your new Ford Tractor has been built with the knowledge gained through manufacturing over two million farm tractors. In it you will find many new and exclusive features, designed to make your work easier, faster and more profitable.

After familiarizing yourself with the tractor controls and instruments, read the following instructions on OPERATION. They will help you obtain maximum efficiency and dependable operation from your new Ford Tractor.



*A careful operator is the best insurance
against accidents.*

OPERATION

PRE-STARTING CHECK

Your Ford Tractor and Implement Dealer has checked your tractor thoroughly. We suggest, however, that you double check the tractor before placing it in operation. Make certain that the crankcase, transmission, hydraulic system and rear axle are filled to the recommended level. Check the tires for proper air pressure and be sure that the radiator is filled with coolant.

FUEL

Normally use Diesel Fuel Oil No. 2 (No. 2D) with a minimum cetane rating of 43. In extremely cold weather, use Diesel Fuel Oil No. 1 (No. 1D) with a minimum cetane rating of 49.

BREAK-IN PROCEDURE

Your new Ford Tractor should provide long and dependable service if given a good start by you, the operator. During the first 50 hours of operation, do not work the tractor at full capacity. Run the engine at slow to medium speeds and use the lower gears wherever possible. Check

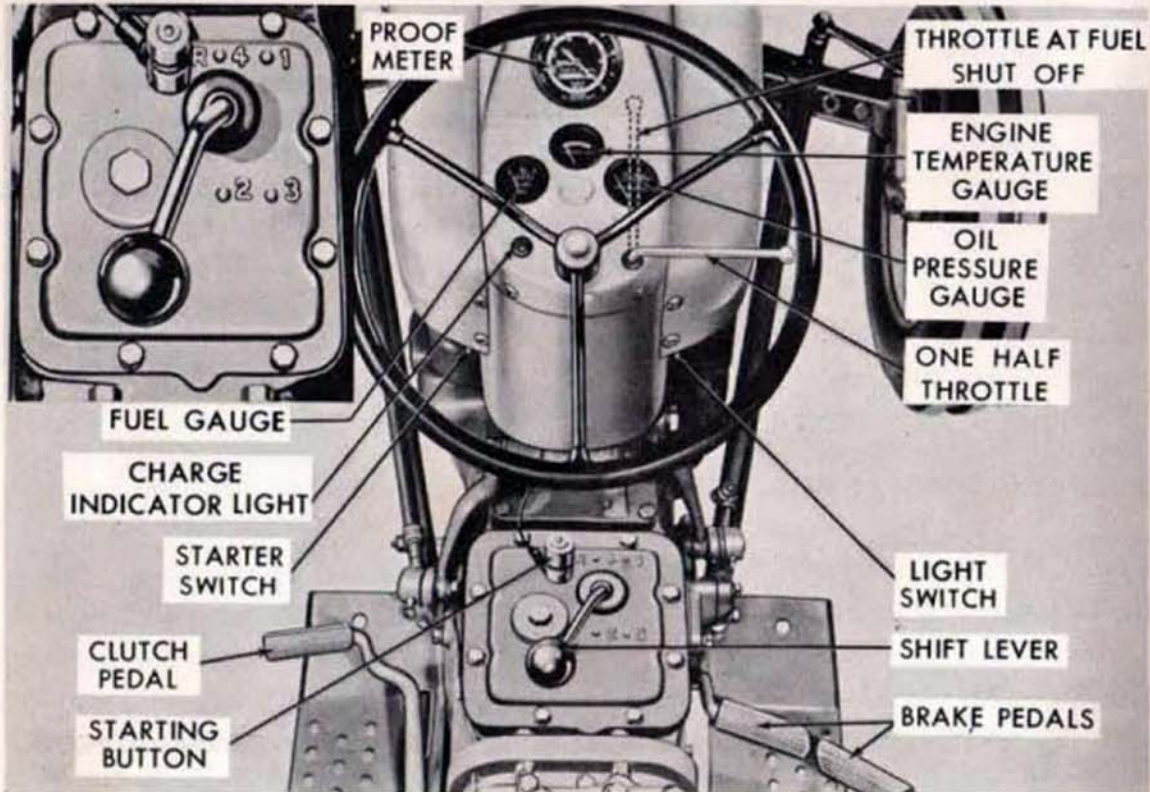

Figure 9
Four Speed Transmission Tractor

the instruments frequently and keep the radiator and oil reservoir filled to the recommended level.

After 50 hours of operation, see your Ford Tractor and Implement Dealer. He will perform all necessary checks and adjustments in the **50 HOUR SERVICE AND INSPECTION**, authorized by your Service Policy.

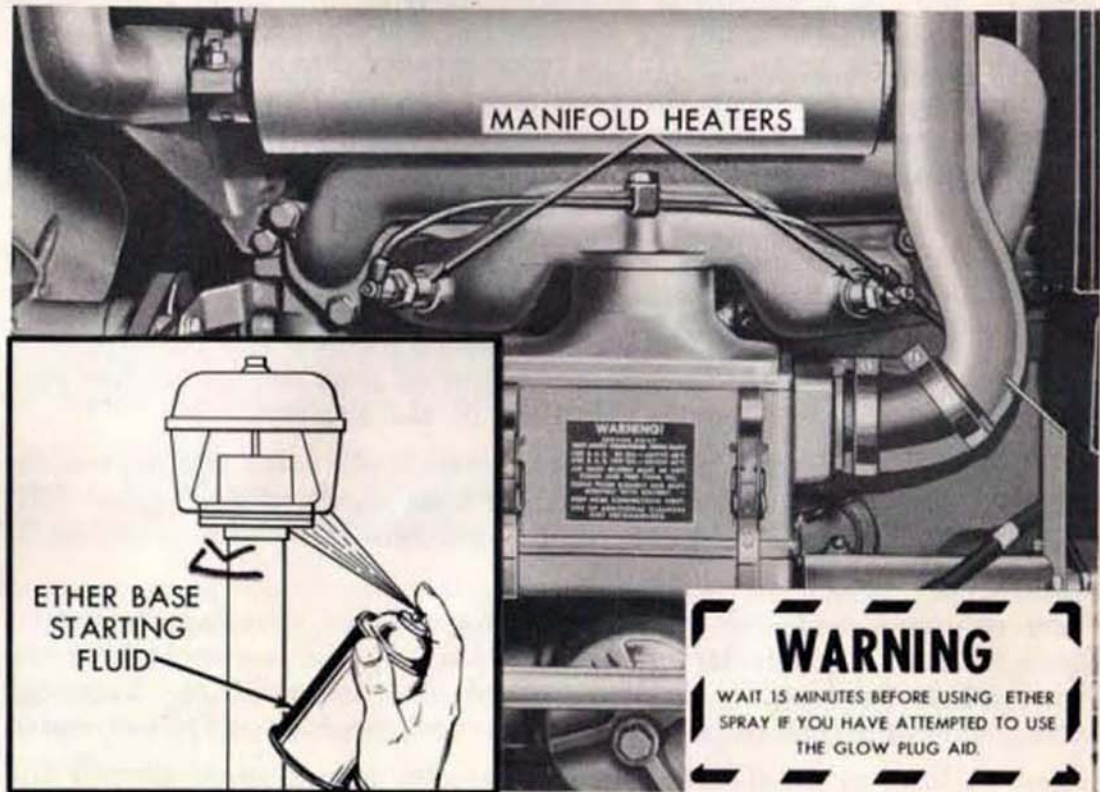

Figure 10
Starting Aid—Manifold Heating Elements

FOUR SPEED TRANSMISSION TRACTOR

Starting the Engine: To start the engine under normal weather conditions, move the throttle down to the half open position, set the gear shift lever in the neutral position and turn the starter switch clockwise. Depress the clutch pedal and press the starter button.

The primary purpose of the electrical circuit in a diesel tractor is to start the engine. Once the engine is running it no longer requires the electrical circuit and it cannot be stopped by cutting off the starter switch. During operation of the tractor, the starter switch is left on to complete the circuit to the generator warning light.

Intake Manifold Heater Kits: Kits are available for use in starting the diesel engine in cold weather (above 15° F.). The manifold heater assembly, Figure 10, is installed in the air intake manifold to heat the air before it enters the combustion chamber. The panel button switch, controlling the electric current to the manifold heating elements is mounted

FOUR SPEED TRANSMISSION TRACTOR (Cont'd)

above the starter key. To operate the manifold heater turn the starter switch on and pull the throttle down to the half open position. Depress the heater circuit button for approximately 30 to 90 seconds, depending on the temperature, release the heater button and proceed to start the engine.

For temperatures below 15° F. it is recommended that an ether base starting fluid be sprayed into the pre-cleaner louver, Figure 10, while the engine is cranked. (Complete instructions are given on the container.) This starting fluid is available in spray type containers at your Ford Tractor and Implement Dealer, or from diesel fuel suppliers.

CAUTION: Wait 15 minutes before using ether spray if you have attempted to use the manifold heater aid.

NOTE: The temperature given above at which the two aids perform satisfactorily will vary according to the length of time the tractor has been inactive and also the general condition of the engine.

Driving the Tractor: Release both rear wheel brake locks and depress the clutch pedal. Next move the gear shift lever to the desired gear. Shift positions are clearly indicated on the transmission cover as shown in Figure 9.

You will save fuel and minimize engine wear by selecting the correct gear ratio for a particular operation. Operating the tractor in low gear with a light load and high engine speed is a waste of fuel. "Lugging" occurs when the load for a particular gear and throttle setting is excessive.

After shifting to the desired gear, increase the engine speed slightly and release the clutch pedal in the same manner you would when driving an automobile. When the tractor is in motion, remove your foot from the clutch pedal and increase the ground speed as desired.

CAUTION: Do not attempt to shift gears while the tractor is in motion. Do not tow the tractor faster than 20 mph.

Stopping the Tractor: To stop the tractor, decrease the engine speed, depress the clutch pedal and apply pressure evenly to both brake pedals until the tractor is stopped. Place the gear shift lever in the neutral position, lock the brakes and move the throttle lever to the closed position to shut off the engine. Turn off the starter switch.

SELECT-O-SPEED TRANSMISSION TRACTOR

Speed Selector Mechanism: The selector indicator, Figure 4, shows the gear selected and the ground speed when the tractor engine is at 1200, 1750, or 2200 rpm. Ten forward speeds (indicated by numerals 1 to 10), two reverse speeds (R_1 and R_2), a park (P), and a neutral (N), can be obtained by means of the gear selector lever. The selector indicator is lighted when the ignition is on.

The ten speed ranges overlap each other and provide speeds from .6

SELECT-O-SPEED TRANSMISSION TRACTORS (Cont'd)

mph in 1st gear at 1200 rpm to 18 mph in 10th gear at 2200 rpm. The two reverse speeds will range from 1.9 mph in R₁ to 5.1 mph in R₂ at 2200 rpm. When moving the lever through the "neutral" position, it will be necessary to hold it outward, otherwise it will drop into the neutral locating notch. Since the transmission can be shifted "on the go," downshifting to 8th, 7th, 4th, 3rd, 2nd, and 1st gears will act as a very effective brake on down grades. The red diagonal marks on the dial for gears 5, 6, and 9 indicate that they are coasting or free wheeling gears. **CAUTION:** Do not shift to these coasting gears when using the transmission as a brake or on down grades.

The park position locks the rear wheels to prevent movement of the tractor. This feature is especially convenient when attaching implements or doing belt work. Any time the engine is not operating, the transmission automatically shifts to park for safety purposes.

Re-Positioning the Selector Lever: For added convenience the selector lever on your tractor can be mounted on either side of the shifter mechanism to permit right or left hand shifting.

To move the selector lever to the opposite side of the shifter mechanism, take off both covers, Figure 4, by removing the Phillips head screw as shown at (1), Figure 11. Remove the selector lever from the shaft and position it on the shaft on the opposite side of the shifter mechanism. Switch the covers and reinstall with the Phillips head screws. Tighten securely.

Selector Lever Stops: Installation of the Lever Position Stops enables the operator to establish a pre-determined shift pattern between two gears.

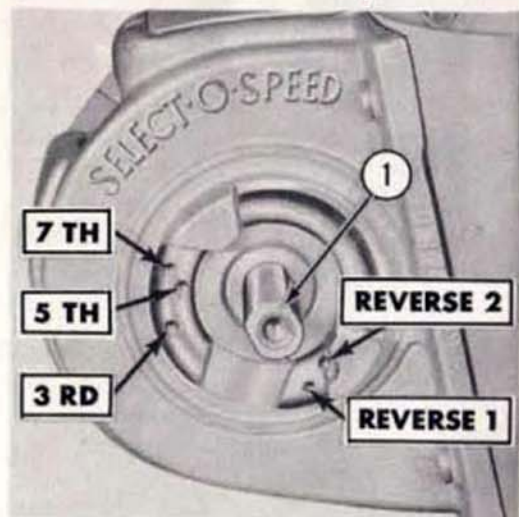

Figure 11
Selector Lever Stop Positions

These stops are especially convenient for loader and other material handling operations. The speed stop screws can be positioned in any two of the gears 3, 5, 7, R₁ or R₂ by inserting them in the holes shown in Figure 11. These stops can be over-riden to obtain any gear by pulling outward on the spring loaded selector lever and shifting to the desired gear. When selector stops are not desired, the stop screws should be placed in the holes on the side opposite the selector lever. Tractors will be shipped from the factory with the stop screws in this location.

SELECT-O-SPEED TRANSMISSION TRACTORS (Cont'd)

CAUTION: The operator should always be seated on the tractor when starting the engine.

Starting the Engine: Place the transmission selector lever in park (P) position, depress the inching pedal and turn the starter switch to the "on" position. Move the throttle lever to approximately $\frac{1}{2}$ open position and press the starter button. For cold weather starting see Intake Manifold Heater Kits on Page 15.

The lubrication light will flash on when the starter switch is turned on and while starting. After the engine starts, the lubrication light will go out. The light may come on momentarily when the inching pedal is partially depressed or during partial engagement of the PTO control knob. If at any time the lubrication light remains on, low oil pressure is evident. Shut off the engine as continued use may result in serious damage to the transmission. Operate the engine at approximately 1000 rpm to sufficiently warm both the engine and transmission oil before subjecting the tractor to a load.

Operating the Tractor: With the engine running and the inching pedal depressed, shift directly to the desired gear if the operation is anticipated to be in the low gear ratios (1 through 4). Shift to one gear below the anticipated operating gear for the higher gear ratios.

Increase the throttle setting to handle the initial load, then let the inching pedal up slowly until the tractor moves off smoothly. Thereafter shift to the speed ratio which will permit the best performance and move the throttle setting accordingly.

Shifting on the Go: It is important when shifting on the go that the selector lever be moved quickly and sharply. This can best be done by placing the lever in the heel of your palm and putting your thumb and forefinger on the ball of the selector cover. To obtain a smooth shift when down shifting to a lower gear ratio under increased load conditions, shift before the engine has a chance to lug. When up shifting to a higher gear ratio, a smoother shift can be obtained if the throttle setting is reduced slightly.

CAUTION: Avoid shifting quickly through a series of gears while at high engine speeds as the sudden speed change may cause the tractor to surge ahead or slow down abruptly.

You will save fuel and minimize engine wear by selecting the correct gear ratio for a particular operation. Operating the tractor in a low gear with a light load and high engine speed is a waste of fuel. "Lugging" occurs when the load for a particular gear and throttle setting is excessive.

Stopping the Tractor: Reduce the throttle setting, downshift the transmission to neutral (N) and apply pressure evenly to both brake pedals until the tractor is stopped. Move the throttle to the closed position to

shut off the engine. Shift the selector lever to park (P) and turn the starter switch off. Additional braking by down-shifting can be accomplished by the use of forward gears other than 5, 6, and 9, which are coasting gears and are indicated by diagonal red marks on the selector indicator. **CAUTION:** Do not shift to these coasting gears when using the transmission as a brake.

NOTE: The foot operated inching pedal interrupts power flow and is operated similarly to a conventional clutch pedal where quick disengagement of rear wheels is desired.

Towing the Tractor: To tow or push a Select-O-Speed Transmission equipped tractor, when the engine is not running, the drive line must be disconnected from the rear axle. This is necessary as the Select-O-Speed Transmission automatically shifts into park whenever the engine stops.

To disengage the transmission, disconnect the traction coupling as follows: Remove the nut (1) Figure 5, and strap; turn the strap over and reinstall on the shaft (2), then rotate the shaft approximately 60° to the rear. Rock the tractor to make sure the transmission is disengaged, and then replace the strap and reinstall the nut to assure that the traction coupling remains disengaged.

NOTE: Do not tow tractor faster than 20 mph.

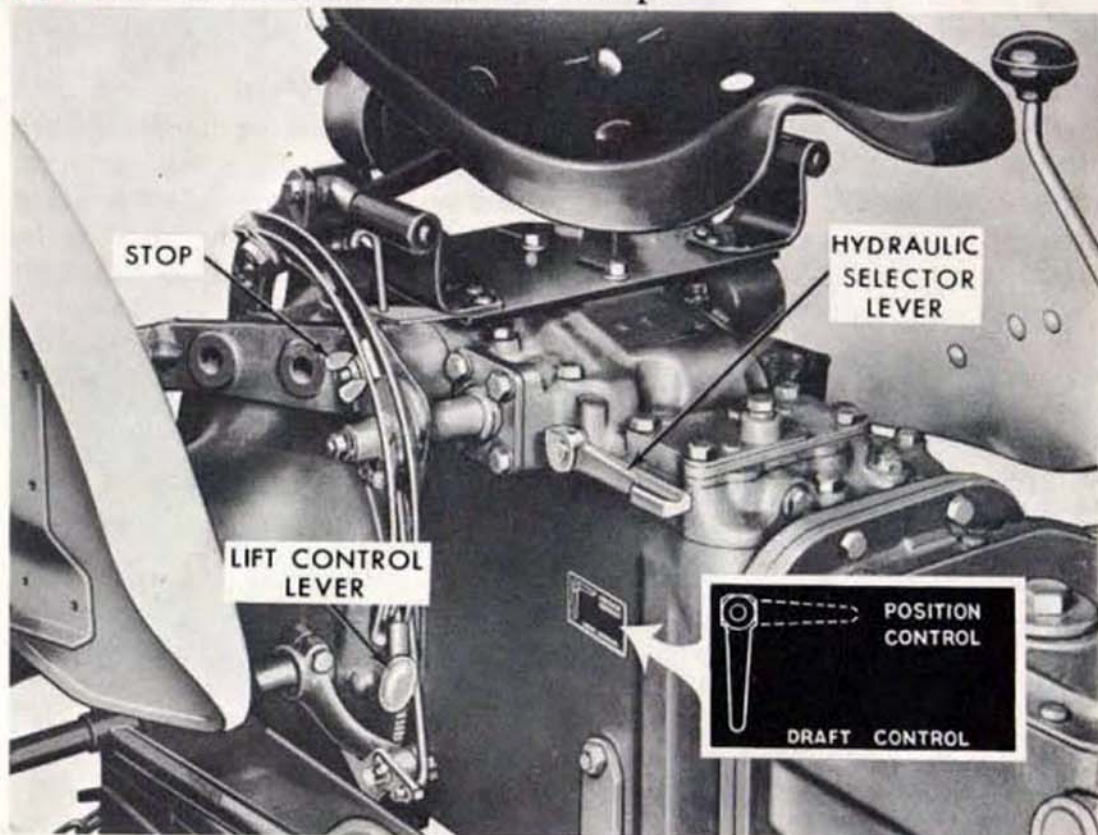

Figure 12
Hydraulic Control Levers

THE HYDRAULIC SYSTEM

One of the outstanding features of your new Ford Tractor is the Live Action Hydraulic System. By simply moving the Lift Control Lever, the system provides instant hydraulic power for raising or lowering a wide variety of implements. Regardless of whether the clutch pedal is up or down, or whether the PTO is engaged or disengaged, the system will respond smoothly, enabling you to adjust implement depth within fractions of an inch.

The system incorporates two types of hydraulic control. Depending upon the type of implement used and the soil conditions and terrain encountered, the system may be operated in Implement Position Control or in Constant Draft Control.

Implement Position Control: To operate the hydraulic system in Implement Position Control, move the hydraulic selector lever at the side of the tractor seat into the "UP" position (see Figure 12), and set the implement at the desired depth by moving the Lift Control Lever down. Where the ground is relatively level, the position control will keep the implement at the desired depth, even though the soil texture may vary.

By setting the adjustable stop on the quadrant, the implement can always be returned to the original depth by moving the Lift Control Lever down to the stop.

Constant Draft Control: With the hydraulic selector lever in the "DOWN" position, as shown in Figure 12, the hydraulic system is operating in Constant Draft Control. When an implement is lowered to work at a certain depth, the draft control will maintain the same draft, even though the ground contour or soil texture may change. If the draft increases, the hydraulic system will respond by raising the implement to decrease the draft. At the same time, the weight will shift to the tractor rear wheels, increasing traction until the implement has been automatically repositioned and the draft is decreased.

When necessary, the operator may use the Lift Control Lever to make small adjustments in the system.

Hydraulic Piston Pump: Your new Ford Tractor is equipped with a piston pump, containing six pistons. The pump is gear driven and provides a constant flow of oil to the Ford Tractor "live action" hydraulic system in volumes which are proportioned to engine speeds. For maximum efficiency of operation and long pump life, always use the recommended hydraulic fluid (Ford Spec. M-4864-A) when filling the tractor hydraulic reservoir. Always use clean containers for this operation. When service on the hydraulic system becomes necessary, see your local Ford Tractor and Implement Dealer. He is properly trained and equipped to meet your service needs.

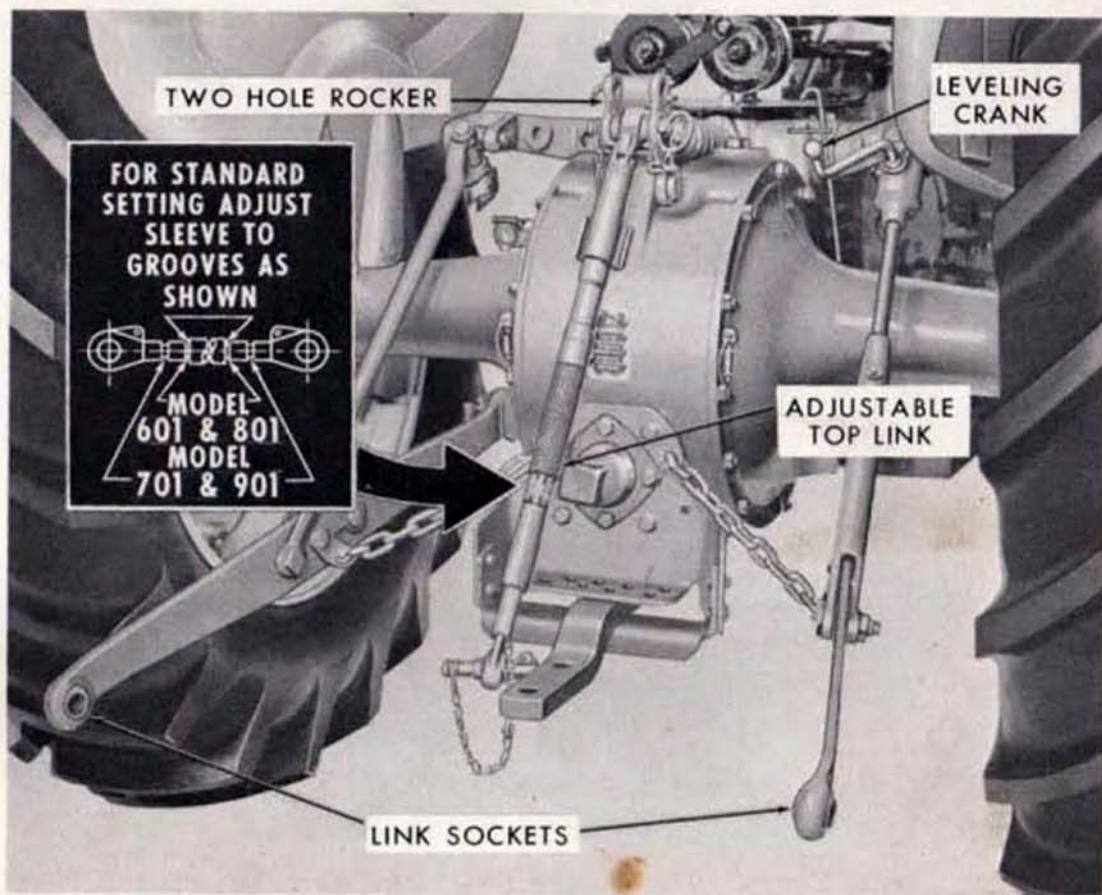

Figure 13
Leveling Crank and Adjustable Top Link

ATTACHING IMPLEMENTS

Most implements can be easily and quickly attached to the tractor three point linkage. With the hydraulic selector lever in Implement Position Control, back the tractor so that the lift links are directly above the cross shaft of the implement. Lower the links with the Lift Control Lever, until the sockets are aligned with the ends of the shaft. Attach the left link to the shaft and secure with the linch pin provided, then adjust the right link with the leveling crank (see Figure 13) and attach it in the same manner. Attach the adjustable top link to the implement and secure it with the linch pin.

Two Hole Hydraulic Lift Rocker: The two hole hydraulic lift rocker on the Ford Tractor provides better control of sensitivity for light and heavy draft implements. Attach the top link in the upper hole for light draft loads (cultivating) and in the lower hole for heavy draft loads such as plowing.

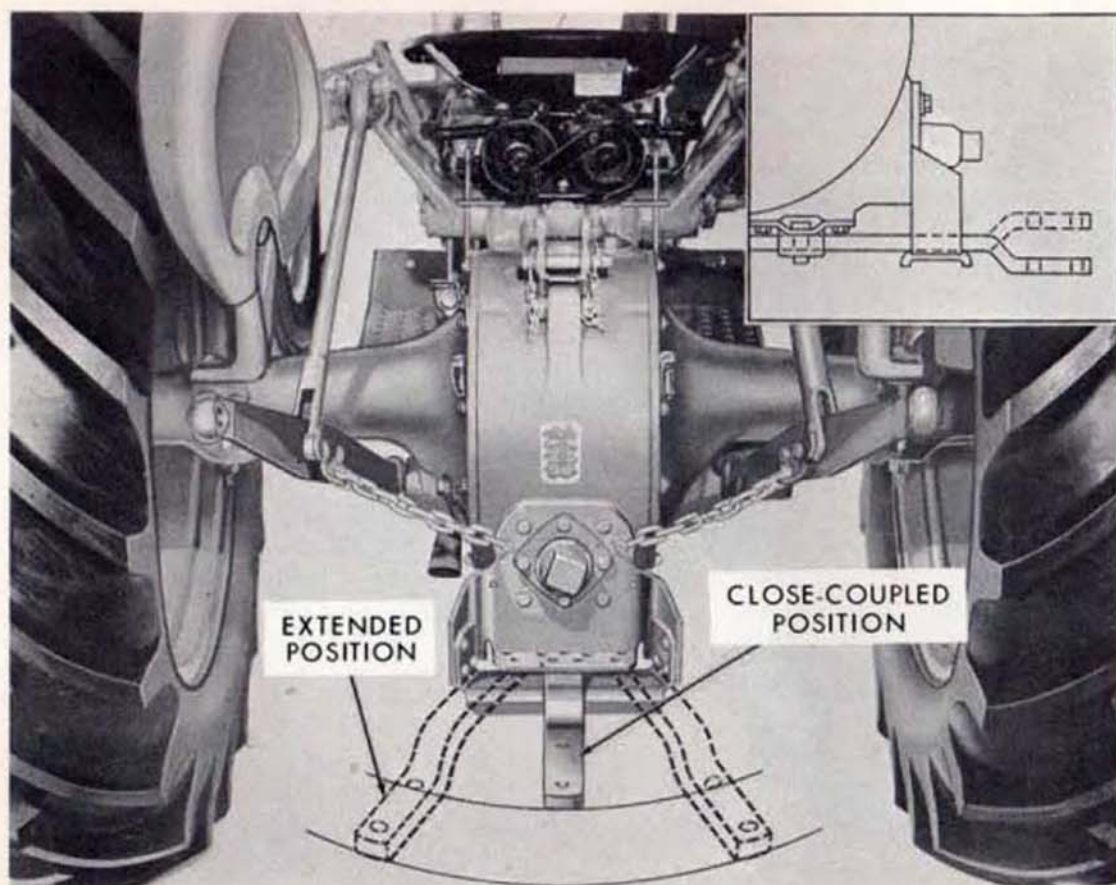

Figure 14
Swinging Drawbar

Adjustable Top Link: The fully adjustable top link provides improved implement performance and operation. The link may be adjusted to suit implement operation requirements by releasing the lock and rotating the sleeve until the desired length is obtained. The standard length of 25 inches is obtained by adjusting the link as shown on a decal located on the sleeve. (See insert, Figure 13.)

SWINGING DRAWBAR

The swinging drawbar on your Ford Tractor permits quick, easy attachment of pull type implements.

The tractor can be operated with the swinging drawbar in either the "close-coupled" or "extended" positions (see Figure 14), and with the offset up or down (see insert, Figure 14). The drawbar may also be set and used in different positions either to the left or right of center (seven in all).

When operating with PTO driven equipment, the drawbar should always be in the "extended" position, with the offset down.

CAUTION: Remove the Swinging Drawbar when attaching close mounted implements.

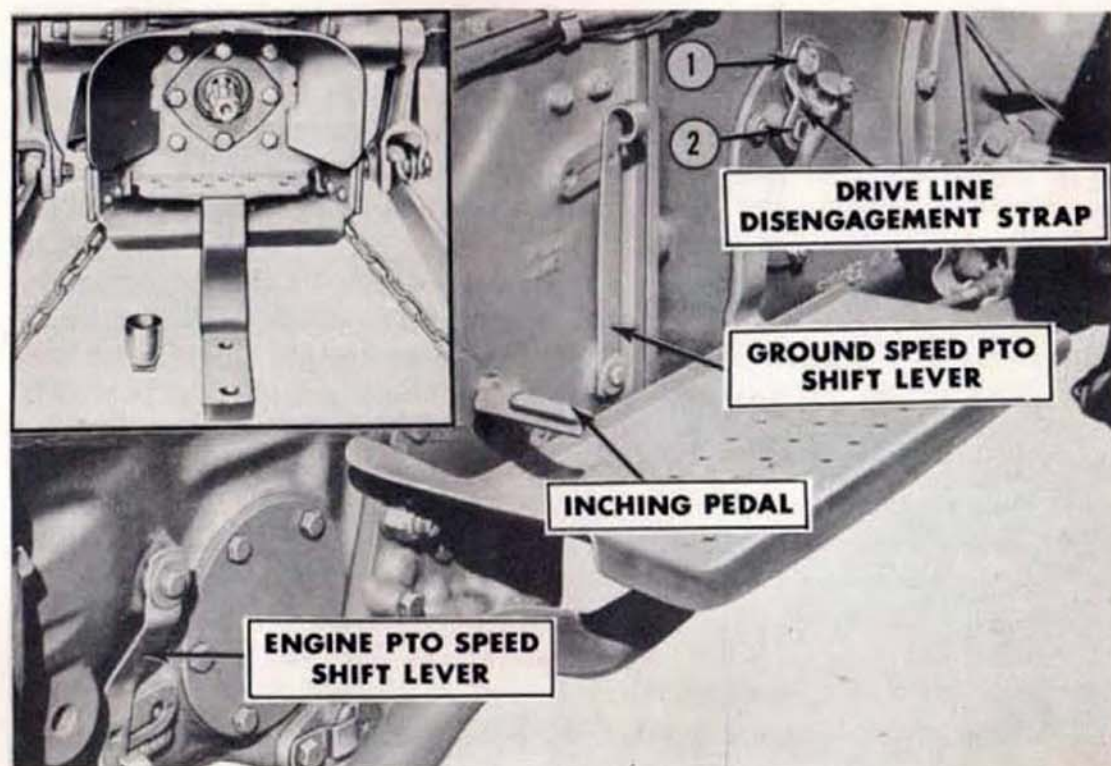

Figure 15
Select-O-Speed Transmission Controls

POWER TAKE-OFF OPERATION

The power take-off transfers engine power directly to mounted or drawn implements, or to belt driven equipment when a pulley is used.

Engine P.T.O. Speeds: The American Society of Agricultural Engineers (A.S.A.E.) standards for power take-off speed are 540 ± 10 revolutions per minute and the new speed of 1000 ± 25 rpm. Most power take-off implements will operate at maximum efficiency when the P.T.O. functions within one of these two ranges.

Power Take-Off Shaft: Your Ford Tractor is equipped with a standard PTO shaft ($1\frac{3}{8}$ " diameter) in accordance with A.S.A.E. specifications for attaching PTO driven equipment built to A.S.A.E. standards. A PTO shield (see insert, Figure 15) is available as extra equipment. This shield should be used as a safety precaution and serves as the supporting member for pull type implement drive line shields in all operations involving PTO driven implements.

4 Speed Transmission Equipped Tractors: The power take-off shaft is engaged by depressing the clutch pedal and moving the PTO lever toward the rear of the tractor (see Figure 3). When engaged, operation of the shaft may be temporarily interrupted by depressing the tractor clutch pedal. To operate a 4-Speed Transmission equipped tractor PTO shaft at the A.S.A.E. standard of 540 rpm, the engine should be operated at 1485 rpm.

Select-O-Speed Transmission Equipped Tractors: Model 671-D and 871-D Tractors have an independent PTO with an A.S.A.E. standard speed of 540 rpm at 1750 engine rpm. Models 681-D and 881-D have two independent PTO A.S.A.E. standard speeds of 540 and 1000 rpm at 1750 engine rpm, plus a proportional ground speed PTO. An independent PTO enables the power take-off shaft to be operated whether or not the tractor is in motion.

The engine speed PTO shaft is engaged by the PTO control knob, Figure 4. For gradual engagement of the PTO shaft, pull the knob out slowly to a point where the load begins to feather in. Pick up the load gradually by pausing briefly or pushing slightly inward as required, then slowly pull the knob to the full out position.

In Model 681-D and 881-D tractors, the desired PTO speed of 540 or 1000 rpm should first be selected using the PTO shift lever, Figure 14. With the tractor engine stopped, shift to the forward position for the 540 rpm speed, or to the rearward position for the 1000 rpm speed.

NOTE: The correct PTO adaptor should be installed on the PTO shaft to conform to the A.S.A.E. spline standards for 540 and 1000 rpm operated implements as described below.

All Model 881-D tractors are factory equipped with a 6-spline adaptor for 540 rpm PTO operation. To use the 1000 rpm PTO speed, the 6-spline PTO shaft adaptor must be replaced with the 21-spline adaptor provided in the tractor tool box. To change the adaptor, loosen the socket head screw located inside the adaptor shaft with the special Allen wrench provided. Change to the other adaptor and tighten the socket head screw securely.

CAUTION: Use the 1000 rpm speed only for implements designed for 1000 rpm use.

In Model 681-D and 881-D Tractors, ground speed PTO permits the operating speed of the implement to be in direct proportion to the forward speed or ground travel of the tractor. For approximately every seven inches of forward travel of the tractor, the PTO shaft will make one revolution, or for every 145 PTO shaft rpm, the rate of forward travel will be 1 mph. Ground speed PTO is totally independent of transmission gear ratio or engine speed. Thus, in such applications as raking, planting, spreading manure, etc., the ground speed PTO will permit a constant implement operating speed for any specific ground speed, regardless of transmission gear ratio.

The ground speed PTO is engaged by moving the ground speed PTO shift lever, Figure 15, to the "ON" position, making certain that the PTO control knob is in the in position. The PTO shaft will only turn when the tractor is in motion. Consequently, to ease into PTO loads, it will be necessary to use the inching pedal. **WHEN BACKING THE TRACTOR, THE GROUND SPEED LEVER MUST BE MOVED TO THE "OFF" POSITION.** Failure to do this may result in serious damage to the implement being operated.

There is a lock-out arrangement within the transmission which prevents the engagement of the ground speed and the engine speed PTO at the same time.

NOTE: Do not shift the ground speed shift lever while the tractor is in motion.

If the implement is designed to operate at either 540 rpm or 1000 rpm, the Select-O-Speed Transmission provides several combinations of gear ratios and engine speeds to obtain these PTO speeds. The following chart illustrates the combinations available to obtain the 540 and 1000 rpm PTO speeds:

Engine Speed and Gear Selection Combinations for Ground Speed PTO

P.T.O. SPEED	540 rpm (Ground Speed 3.7 mph)				1000 rpm (Ground Speed 6.9 mph)		
	Engine rpm	2067	1600	1395	1045	2010	1200
Gear Selection	5	6	7	8	8	9	10

CAUTION: Never operate a PTO Driven implement at speeds exceeding manufacturer's recommendations.

BELT PULLEY

A nine-inch belt pulley is available as an accessory for use on your Ford Tractor. The pulley can be installed in any one of four positions; however, it should not be installed in the up position. To install, remove

CAUTION: NEVER INSTALL OR REMOVE BELT WHILE PULLEY IS IN MOTION.

PROPER SIZE OF THE DRIVEN PULLEY*

Engine R.P.M. 4-Speed Transmission	Engine R.P.M. Select-O-Speed Trans. (Low Range)	Nine Inch Pulley R.P.M.	R.P.M. OF THE DRIVEN PULLY									
			600	800	1000	1200	1400	1800	2200	2600	3000	
1000	1154	679	10	7½	6	5	4½	3½	3			
1100	1269	747	11	8½	6½	5½	5	3½	3			
1200	1385	815	12	9	7½	6	5	4	3½	3		
1300	1499	882	13	10	8	6½	5½	4½	3½	3		
1400	1614	950	14	10½	8½	7	6	4½	4	3½	3	
1500	1730	1018	15	11½	9	7½	6½	5	4	3½	3	
1600	1845	1086	16½	12	10	8	7	5½	4½	4	3½	
1700	1961	1154	17½	13	10½	8½	7½	6	4½	4	3½	
1800	2076	1222	18½	13½	11	9	8	6	5	4	3½	
1900	2192	1290	19½	14½	11½	9½	8½	6½	5½	4½	4	
2000	—	1358	20½	15½	12	10	8½	7	5½	4½	4	

*Figures are computed to the nearest ½ inch pulley size.

the PTO safety cap, the drawbar, the drawbar hanger and the check chains. Then position the pulley assembly on the PTO shaft as desired and secure with the four stud bolts and lock washers provided.

NOTE: On Select-O-Speed Transmission equipped tractors, the 6-spline PTO shaft adaptor must be installed to operate the belt pulley.

For best performance, most stationary machinery must be operated at the correct belt speed. The A.S.A.E. has established a standard range for belt speeds of from 3000 to 3200 feet per minute. A belt speed within this range is reached with a standard nine-inch belt pulley when the Proof-Meter indicates 1750 engine rpm for the 4-Speed Transmission equipped tractor and 2200 engine rpm for the Select-O-Speed Transmission equipped tractor.

CAUTION: Do not operate the belt pulley with the engine PTO speed shift lever in the 1000 rpm position.

The belt speed is dependent on the size of the belt pulley and the pulley rpm. Belt driven implements which do not meet A.S.A.E. standards should be operated at the speed recommended by the manufacturer. To obtain this speed, select a driven pulley of the proper size from the table on page 25.

WHEEL TREAD ADJUSTMENTS

The unique design of the Ford Tractor permits a wide range of front and rear wheel adjustments which can be made quickly and easily.

Front Wheel Tread Adjustment: The front wheels are adjustable from 52 to 76 inches in 4 inch spacings. To change the tread width, raise the front end of the tractor with a jack and remove the bolts which hold the outer axle sections to the center section. Move the front wheels apart until the desired tread width is obtained (see Figure 16), then replace the bolts and tighten securely. Always leave one or more open holes between the bolts.

When absolutely necessary, an 80 inch tread width can be obtained by setting the axle for the 72 inch tread width and then reversing the wheels.

NOTE: When front wheel adjustments are made, the drag links must be adjusted to obtain proper front wheel toe-in. See page 52 under MAINTENANCE.

Rear Wheel Tread Adjustments: The tractor rear wheels are adjustable to the same tread widths as the front wheels. Tread width settings are made by changing the position of the steel discs and the rims to any of the positions from 52 inches to 76 inches shown in Figure 17. To change from the 52 inch tread width to the 72 inch width, it is only necessary to change the wheels from one side of the tractor to the other. Two other wheel changes are similar as shown at the top of Figure 17.

the PTO safety cap, the drawbar, the drawbar hanger and the check chains. Then position the pulley assembly on the PTO shaft as desired and secure with the four stud bolts and lock washers provided.

NOTE: On Select-O-Speed Transmission equipped tractors, the 6-spline PTO shaft adaptor must be installed to operate the belt pulley.

For best performance, most stationary machinery must be operated at the correct belt speed. The A.S.A.E. has established a standard range for belt speeds of from 3000 to 3200 feet per minute. A belt speed within this range is reached with a standard nine-inch belt pulley when the Proof-Meter indicates 1750 engine rpm for the 4-Speed Transmission equipped tractor and 2200 engine rpm for the Select-O-Speed Transmission equipped tractor.

CAUTION: Do not operate the belt pulley with the engine PTO speed shift lever in the 1000 rpm position.

The belt speed is dependent on the size of the belt pulley and the pulley rpm. Belt driven implements which do not meet A.S.A.E. standards should be operated at the speed recommended by the manufacturer. To obtain this speed, select a driven pulley of the proper size from the table on page 25.

WHEEL TREAD ADJUSTMENTS

The unique design of the Ford Tractor permits a wide range of front and rear wheel adjustments which can be made quickly and easily.

Front Wheel Tread Adjustment: The front wheels are adjustable from 52 to 76 inches in 4 inch spacings. To change the tread width, raise the front end of the tractor with a jack and remove the bolts which hold the outer axle sections to the center section. Move the front wheels apart until the desired tread width is obtained (see Figure 16), then replace the bolts and tighten securely. Always leave one or more open holes between the bolts.

When absolutely necessary, an 80 inch tread width can be obtained by setting the axle for the 72 inch tread width and then reversing the wheels.

NOTE: When front wheel adjustments are made, the drag links must be adjusted to obtain proper front wheel toe-in. See page 52 under MAINTENANCE.

Rear Wheel Tread Adjustments: The tractor rear wheels are adjustable to the same tread widths as the front wheels. Tread width settings are made by changing the position of the steel discs and the rims to any of the positions from 52 inches to 76 inches shown in Figure 17. To change from the 52 inch tread width to the 72 inch width, it is only necessary to change the wheels from one side of the tractor to the other. Two other wheel changes are similar as shown at the top of Figure 17.

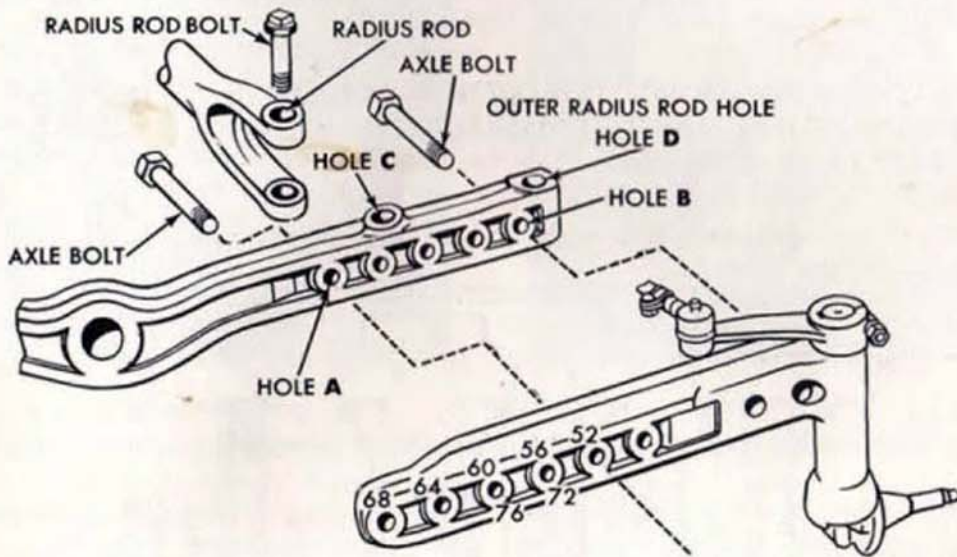

FOR TREAD WIDTH (INCHES)	LINE UP HOLE A AND HOLE NO.	LINE UP HOLE B AND HOLE NO.	SPACE BOLTS APART (INCHES)	SET RADIUS ROD TO HOLE	RADIUS RODS SPREAD (INCHES)
52	52		8½	C	29.08
56	56		8½	C	29.08
60	60		6¾	D	40.82
64	64		8½	D	40.82
68	68		8½	D	40.82
72		72	6¾	D	40.82
76		76	4¼	D	40.82
80†		72	6¾	D	40.82

† REVERSE WHEELS ON AXLE HUBS.

NOTE: ADJUST DRAG LINKS—SEE FRONT WHEEL TOE-IN

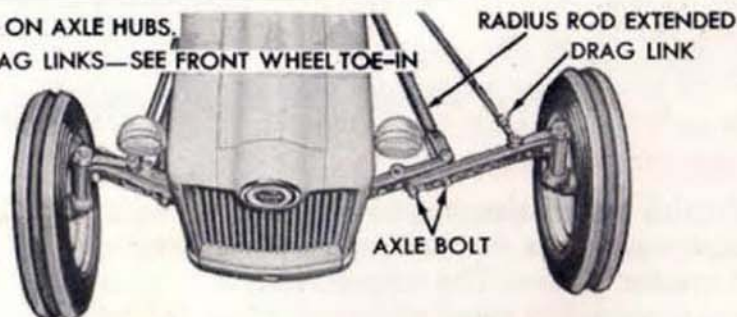

Figure 16
Front Wheel Tread Adjustments

Cast Iron Rear Wheels: Cast iron rear wheels are available as an option for Series 801-D Ford Tractors. These wheels permit manual spacing of 52, 56, 60 or 64 inches. The wheel discs are not reversible with respect to the rim, but there are two sets of mounting pads provided on each wheel. Additional weight can be added by using the washer type weights available at your Ford Tractor Dealership.

NOTE: THE ARROW ON THE SIDE WALL OF THE TIRE SHOULD ALWAYS POINT IN THE DIRECTION OF FORWARD ROTATION OF THE WHEEL.

INTER-CHANGING REAR WHEEL ASSEMBLIES GIVE THESE COMBINATIONS

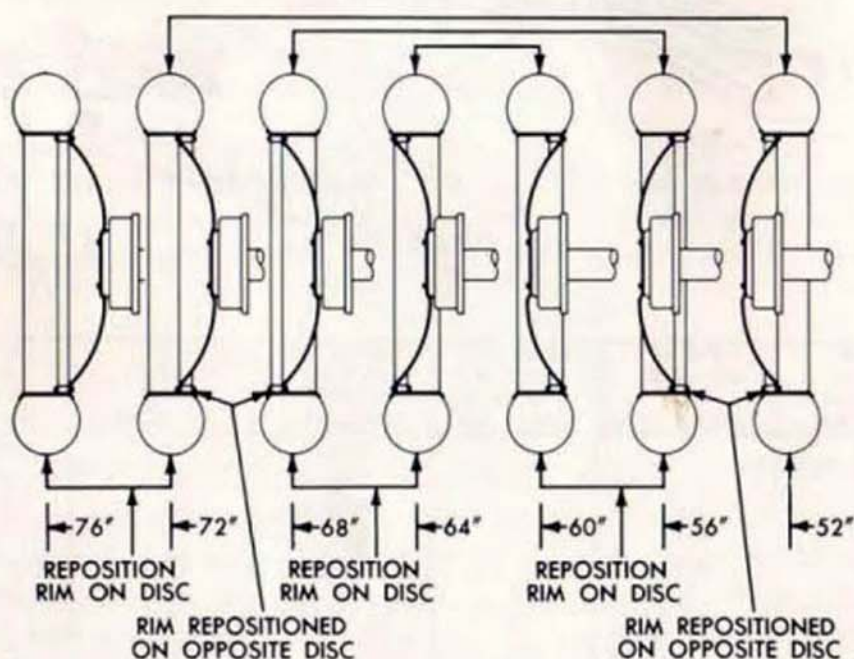

Figure 17
Rear Wheel Tread Adjustments

POWER ADJUSTED REAR WHEELS

If your Ford Tractor is equipped with Power Adjuster Rear Wheels, you will be able to change the rear wheel tread width quickly and easily by means of tractor power. The wheels may be spaced from 56 to 84 inches in 2 inch intervals. For tread widths of 56 to 76 inches, adjust the wheels, one at a time, as follows:

Loosening Tire Rim from Disc: Loosen the nuts on the three locking clamps (see Figure 18), slide the clamps toward the center or retracted position, then retighten the nuts securely. Move the tractor until the wheel tread spacer clamp (Figure 18) is at the top of the wheel, then remove the spacer clamp from the disc by removing the nut.

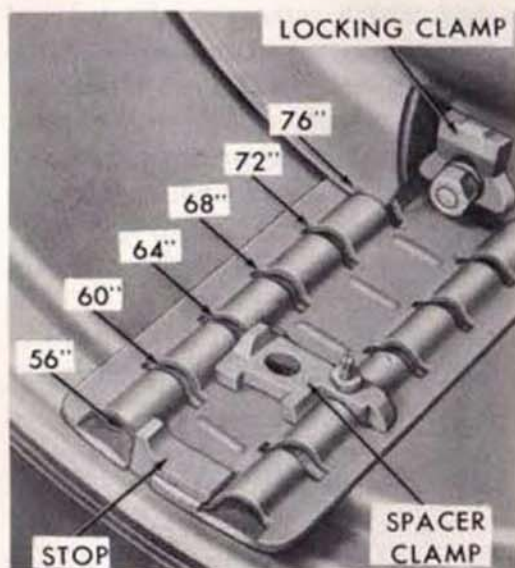

Figure 18

Adjusting Wheels (Normal Position)

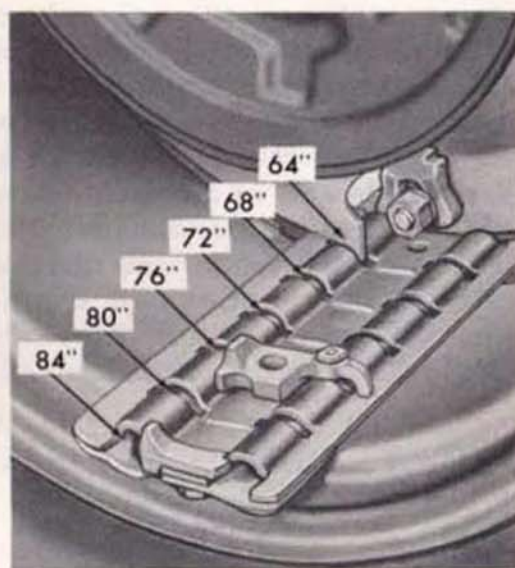

Figure 19

Adjusting Wheels (Reversed Position)

Operating Wheel Disc in the Rim: When setting a wheel at the extreme inner or outer position, loosen the tire rim from the disc, then simply move the wheel in or out to either end stop. For settings between 56 and 76 inches, first move the wheel to the extreme outer position by engaging the clutch, with the tractor engine at idle speed. Use reverse gear for the left wheel and forward gear for the right wheel.

NOTE: Brake the opposite wheel slightly and allow the tractor to creep forward or rearward while the wheel is being adjusted.

Next, place the spacer clamp in the channel thread bar which has stops at each end. Position the clamp for desired tread width and secure as shown in Figure 18. These settings will permit a full revolution, or adjustment of 2 inches for the wheel.

Rotate the disc back into the rim by engaging the clutch with the engine at idling speed. Use reverse gear for the right wheel and forward gear for the left wheel. Disengage the clutch as soon as the disc strikes the spacer clamp.

Securing Rim in Position: Move the tractor so that the spacer clamp can be replaced at the top of the wheel, then remove the clamp from the rim and reinstall it in the wheel. Tighten the nut securely. Loosen the nuts which hold the three locking clamps. Move the clamps out of the lock position, then center the rim in the wheel by tightening the bottom locking clamp. Secure the remaining two clamps. Tighten the nuts in sequence, and make sure the clamps are positioned at approximately the same angle.

NOTE: Check the nuts for tightness after the tractor has been operated for a short time.

Changing Wheel Discs: To obtain a tread width setting of 80 inches, it is only necessary to power-adjust the wheels to a normal 60" setting (see Figure 17), then reverse the wheels on the tractor. The 84" setting is obtained in the same manner by setting the wheels at 56" and reversing them on the tractor. With the wheels in the reversed (dish in) position, it will be necessary to set the spacer clamp and locking clamps from the inside of each wheel when making adjustments. See Figure 18. Disengage the spacer and the locking clamps, move the wheel to its extreme "in" position and set the spacer clamp as desired. Then, use the tractor power to adjust the wheels to the desired width. After adjusting, replace the spacer clamp and locking clamps and tighten securely.

NOTE: THE ARROW ON THE SIDE WALL OF THE TIRE SHOULD ALWAYS POINT IN THE DIRECTION OF FORWARD ROTATION OF THE WHEEL.

WHEEL WEIGHT

To assure sufficient traction for maximum performance in heavy draft operations, weight should be added to the Ford Tractor.

Liquid Ballast: It is a common practice to add weight by filling the rear tractor tires with liquid. A solution of calcium chloride is recommended because of its lower freezing point, and greater weight per gallon than water.

The use of liquid ballast in the front tires will help counter-balance heavy rear mounted implements, and will further increase the traction and "pull-power" of your Ford Tractor in heavy draft operations. The recommended liquid capacities for tires are shown in the table below. This table is based on a 90% fill of the tires with 5 pounds of calcium chloride per gallon of water. The addition of this amount of calcium chloride will prevent freezing in most locations. A 90% fill of tires requires special equipment. See your Ford Tractor and Implement Dealer. For valve level filling of the tires listed, multiply the respective figures in the table by .8 to obtain the necessary information.

MAXIMUM CALCIUM CHLORIDE SOLUTION CAPACITIES

Size of Tire	Pounds of Calcium Chloride	Gallons of Water	Weight of Solution
10-28 4-ply.....	116	23	310 lbs.
11-28 4-ply.....	164	32	440 lbs.
12-28 4-ply.....	187	38	504 lbs.
6:00-16 4-ply.....	30	6	80 lbs.
5:50-16 4-ply.....	25	5	65 lbs.
6:50-16 6-ply.....	29.5	5.9	79 lbs.
7:50-16 6-ply.....	45	9	120 lbs.
13-24 4-ply.....	219	44	584 lbs.
14-24 6-ply.....	266	53	707 lbs.

Cast Iron: In heavy work such as plowing and discing, added weight is necessary in most cases to provide sufficient traction to utilize the maximum power of the engine. Special cast iron weights are available, at extra cost, in different sizes for use on the Ford Tractor. These individual weight sections can be easily attached to or detached from the wheels as the job requires. On lighter jobs, removal of the weights will increase the operating economy of your tractor. The following chart describes the different types of weights and their recommended usage.

NOTE: For 13 x 24 and 14 x 24 rear tires, Regular Duty Vari Weights can be mounted at the 56" setting only, by extending the mounting discs with another set of bolts.

FORD TRACTOR WHEEL WEIGHTS FOR ALL PURPOSE AND SPECIAL UTILITY MODELS	SERIES 601-D		SERIES 801-D	
	Farm Use	Industrial Use	Farm Use	Industrial Use
FRONT (per tractor set) Wheel Weights—Inside mounted Two per wheel—50 lbs. each Total—200 lbs.	X	X	X	X
REAR (per tractor set) Regular Duty Weights Two Mounting Discs—68 lbs. Segments—(24) 30 lbs. each Bolts—12 lbs. Total—800 lbs. *Heavy Duty Weights Two Mounting Discs—68 lbs. Segments—(24) 45 lbs. each Bolts—12 lbs. Total—1160 lbs. Inside Segmented (Special Utility) Segments (6)—133 lbs. each Total—798 lbs.	X	X	X	X

*CAUTION: Under no circumstances should Heavy Duty Weights be used on Series 601-D Tractors.

Weight added to the tires, together with the weight of the mounted implement and tractor, should not exceed the recommended weight to be carried by the tires. The following table lists the maximum recommended weight that can be carried without overloading the tires.

MAXIMUM RECOMMENDED WEIGHT CHART

Tire Size		Inflation Pressure	Maximum Lbs. Tire Load Per Wheel
Rear:			
10-28	4-ply	12	1575
11-28	4-ply	12	1890
		14	2070
12-28	4-ply	14	2430
13-24	4-ply	14	2700
14-24	6-ply	16	3560
Front:			
5.50-16	4-ply	20	655
5.50-16	4-ply	24	725
5.50-16	4-ply	28	795
5.50-16	4-ply	32	860
6.00-16	4-ply	20	750
6.00-16	4-ply	24	835
6.00-16	4-ply	26	875

MAINTENANCE

How long and how well your Ford Diesel Tractor continues to give satisfactory performance depends largely upon proper maintenance. Keep the tractor in good working order by following the instructions in this section on lubrication, mechanical maintenance, minor adjustments and storage.

When major overhauls become necessary, see your Ford Tractor and Implement Dealer. He is interested in you and your tractor, and is properly equipped to meet your service needs.



*A properly maintained tractor
is a Safe tractor.*

INSPECTION

PRE-DELIVERY INSPECTION

Before your tractor was delivered to you, the dealer performed a pre-delivery inspection which is the first step in the maintenance schedule of your tractor. Some of the more important items checked by your dealer are the cooling system, front end, engine, transmission, hydraulic system, power steering system, differential, final drive housings and the general physical condition of your new tractor. A detailed listing of the inspections performed is shown on your Service Policy under the Pre-Delivery and 50-Hour Inspection Reports.

50-HOUR INSPECTION

After you have operated your tractor for a period of fifty hours, see your Ford Tractor and Implement Dealer. At this time, he will perform the factory recommended 50-Hour Inspection, without charge, except for lubricants. Remember that the dealer is interested in your tractor's performance. See him periodically for continued good service.

LUBRICATION

Since your tractor will be subjected to a variety of operating conditions, it is extremely important that all moving parts be lubricated at the proper time. Use clean containers and recommended grades of lubricant to avoid causing serious damage to your tractor.

The following guide describes, in hourly intervals, all of the lubrication services required by your tractor. These time intervals are based on average working conditions. When operating under extremely hot or dusty conditions, lubricate the tractor more frequently.

The location of the lubrication points described in the lubrication guide are shown in Figures 25 and 26 on pages 40 and 41.

SERVICE DAILY OR EVERY TEN HOURS

Crankcase Ventilating System: Remove the element in the Rocker Arm Cover Breather and clean with a suitable solvent. Coat the element with light engine oil before replacing.

Fuel Filter: The fuel filter should be drained daily to remove any water from the fuel system. This is done by opening the drain cock at the rear of the filter base and allowing the fuel to drain for several seconds.

NOTE: It is necessary to bleed the fuel filter only when changing the filter element or when it is suspected that air is trapped in the system. See bleeding the fuel filter, page 38.

Air Cleaner: The air cleaner assembly is of the oil bath type and is attached to the intake manifold. It receives its air supply through an inlet stack which is connected to the pre-cleaner shown in Figure 10.

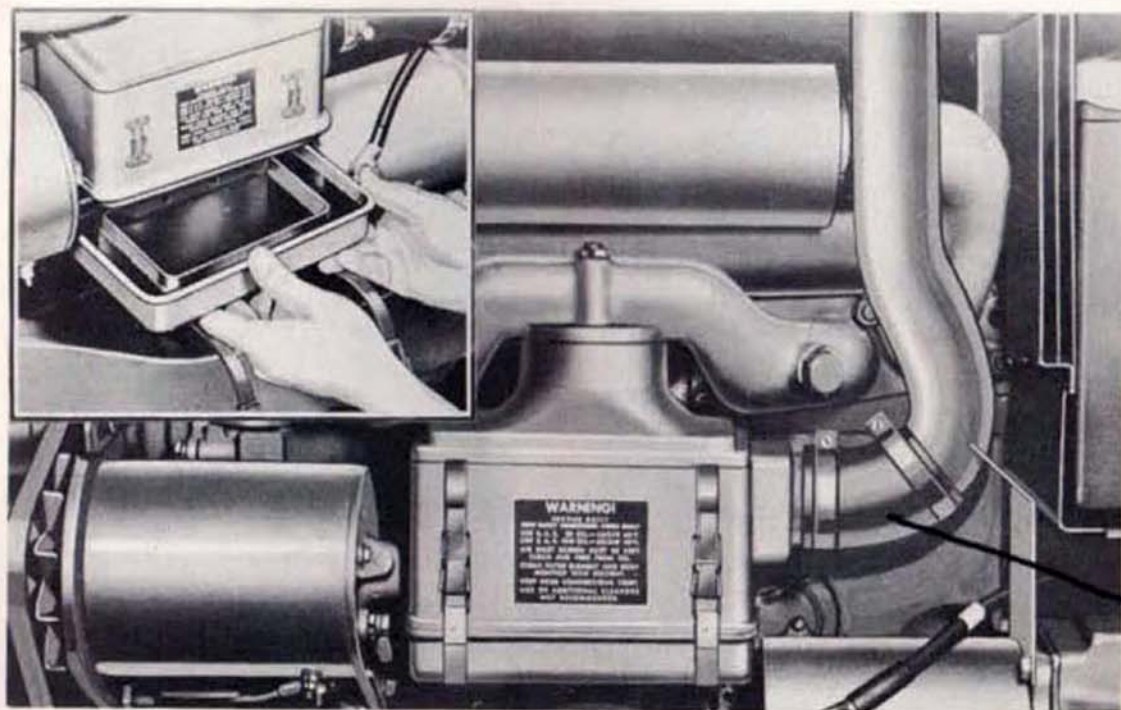

Figure 20
Air Cleaner Maintenance

The air cleaner oil bath tray should be emptied and cleaned thoroughly after each day's use or every ten hours. Refill the tray to the oil level mark (one pint) with engine crankcase oil.

CAUTION: Do not use any oil in the cup other than specified. Light weight engine oil can be sucked into the firing chambers and cause a run-away engine.

Pre-Cleaner: The pre-cleaner has a dirt level marked on the side of the container and must be serviced as the dust particles approach this level. The pre-cleaner operates on an air swirl principle, and should the dirt be allowed to accumulate above this point, the air will tend to draw the particles directly into the air cleaner.

Only the operator can determine the exact requirements for servicing the air system on his tractor based on the conditions under which it is operated. Both the air cleaner and pre-cleaner should be inspected frequently when first operating under dusty conditions to determine the correct servicing interval.

Pressure Type Fittings: Clean the fittings on the Lift Link Leveling Box and Fork, Front Axle Spindles, Clutch Pedal and Steering Drag Links. Apply pressure gun grease and wipe the fittings clean. See Figures 25 and 26.

Crankcase Dip Stick: Remove the dip stick from the right side of the engine crankcase. Always wipe the dip stick with a clean cloth, replace it and then remove it again to determine the oil level. Maintain the level at



Figure 21
Crankcase Oil Level Dip Stick

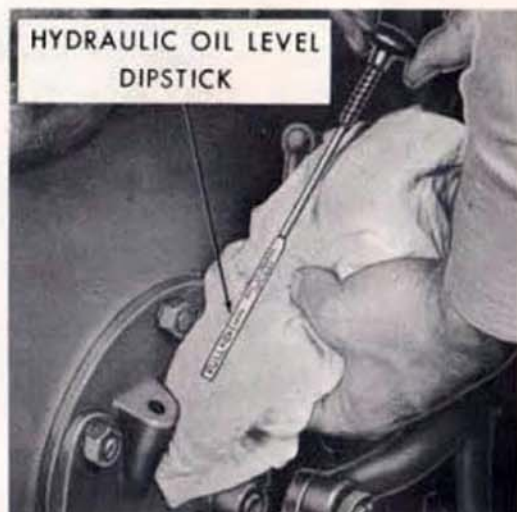

Figure 22
Hydraulic Oil Level Dip Stick

the full mark with a reputable brand of diesel engine oil API class DM or DS (see Service Every 100 Hours).

Hydraulic System Dip Stick: Use the side of the dip stick that is marked "HYDRAULIC SYSTEM, ALL CYLINDERS EXTENDED." Check the level of the hydraulic oil and maintain at the full mark with the proper lubricant as recommended under SERVICE EVERY 600 HOURS. Make certain that all hydraulic cylinders are fully extended as noted on the dip stick, and that the hydraulic lift links are in the raised position.

SERVICE EVERY 100 HOURS

Engine Crankcase: Change the engine oil in your new tractor at the 50 hour inspection and every 100 hours of operation thereafter. Drain the oil after the engine has reached normal operating temperature. Refill the crankcase with four quarts of the recommended engine oil and add one extra quart of oil if the filter cartridge is replaced.

Recommended Engine Oils: It is recommended that a reputable brand of diesel engine oil be used.

SAE—30—Temperature above 55° F.

SAE—20-20W—Temperature 20° F. to 55° F.

SAE—10-10W—Temperature below 20° F.

Oils marked with the API Service Classification DM or Supplement 1 (S1) are satisfactory for use under normal operating conditions.

Oils marked with the API Service Classification DS or Series 3 are satisfactory for all engine operation and are strongly recommended when any one or a combination of the following conditions may be encountered.

- (a) High air temperatures
- (b) Intermittent operation at low temperatures
- (c) Fuel contains high sulfur content.

Air Cleaner: To service, loosen the two hose clamps at the air inlet tube to air cleaner connection. Remove the air cleaner and jacket from the intake manifold. Remove the oil bath tray and clean thoroughly. Immerse the air cleaner assembly in clean diesel fuel, flush and drain thoroughly. Reattach the air cleaner and fill the tray to the oil level mark (one pint) with engine crankcase oil.

Rear Axle: Remove the rear axle inspection plug (10), Figure 25, and check the level of the oil. If necessary, add oil. (See SERVICE EVERY 600 HOURS.)

4-Speed Transmission: Remove the transmission oil level inspection plug (18), Figure 25, and add oil, if required. (See SERVICE EVERY 600 HOURS.)

Select-O-Speed: The Select-O-Speed Transmission is hydraulically operated and pressure lubricated, so it is very important that the proper lubrication level be maintained at all times. When adding lubricant, use only M-2C41 Ford Universal Hydraulic Lubricant.

Check the oil level by removing the oil level check and filler plug and add oil as required. Always use the utmost caution to insure that no foreign material gains access to the transmission reservoir when either removing the filler plug or adding oil to the transmission. (See SERVICE EVERY 1200 HOURS.)

Steering Housing: Check the oil level at the steering gear case plug (16), Figure 25, and add lubricant as required. Use extreme pressure gear lubricant SAE 90 in the summer and SAE 80 in the winter.

Power Steering Pump Reservoir: Check the oil level every 100 HOURS OF OPERATION. Remove the pump reservoir top and refer to the decal on the reservoir. For an accurate reading, the tractor wheels should be turned to the left against the stops.

CAUTION: Use only AUTOMATIC TRANSMISSION FLUID—TYPE "A" or oil meeting Ford specification M-2C41 in the Power Steering System. Always use clean fluid. Dirty fluid may cause extensive damage to the system.

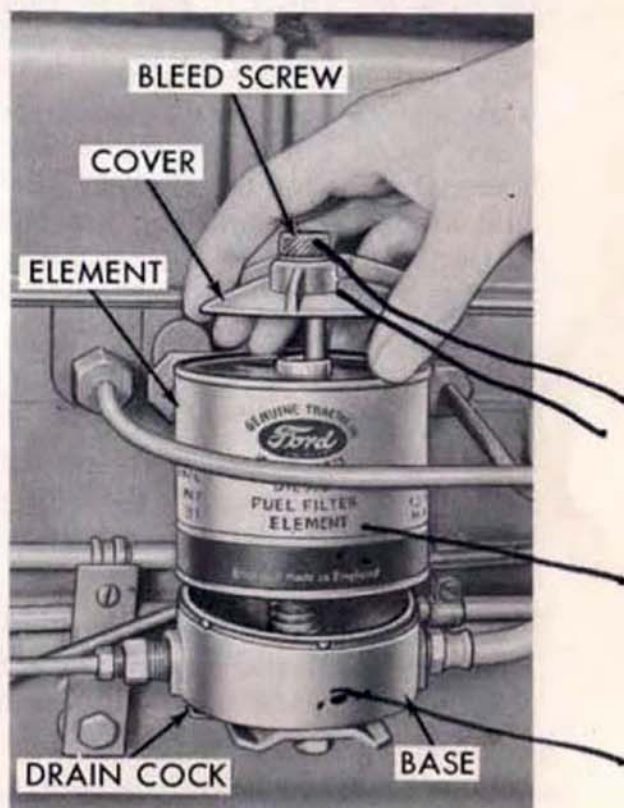

Figure 23
Replacing Filter

SERVICE EVERY 200 HOURS

Oil Filter: Replace the filter with every other engine oil change and add one quart of engine oil to fill the new filter.

Generator: Oil the rear bearing with light oil. Do not over lubricate.

SERVICE EVERY 400 HOURS

Fuel Filter: The fuel filter element should be replaced after every 400 hours of operation. To replace the element close the fuel shut-off valve located at the bottom center of the tank, shown in Figure 24. Open the drain cock at the bottom rear of the filter base, Figure 23, and drain the fuel into a drain pan. Remove the cover assembly and filter element by turning the cover counterclockwise.

NOTE: The filter element is spring loaded and will raise from the filter base as the cover assembly is backed off. To prevent dirt from entering the outlet line to the fuel pump, the spring loaded seal will cover the opening when the filter is removed. This should remain in place when changing the filters. There are two filter element gaskets located one at the top and one at the bottom of the element. The gaskets and element should be discarded.

Wipe out the inside of the filter base with a clean rag and flush with clean diesel fuel allowing the fuel to drain through the drain cock. Clean the cover and bolt assembly in diesel fuel.

Position the new element over the rubber grommet on the center post of the filter base. Place the cover and bolt assembly through the center core of the element and depress the element slightly to start the bolt threads. Tighten the cover and bolt assembly finger tight and then open the fuel shut-off valve.

After installing a new element, bleed the fuel filter. This is done by opening the drain cock at the bottom rear of the fuel filter base. The fuel will flow by gravity from the tank to the filter. When the fuel starts to flow through, close the drain cock. Open the air bleed screw located at the top of the filter assembly two turns to release the trapped air. When the air bubbles disappear, close the bleed screw.

NOTE: Never open the bleed screw when the engine is running as air will be sucked into the system.

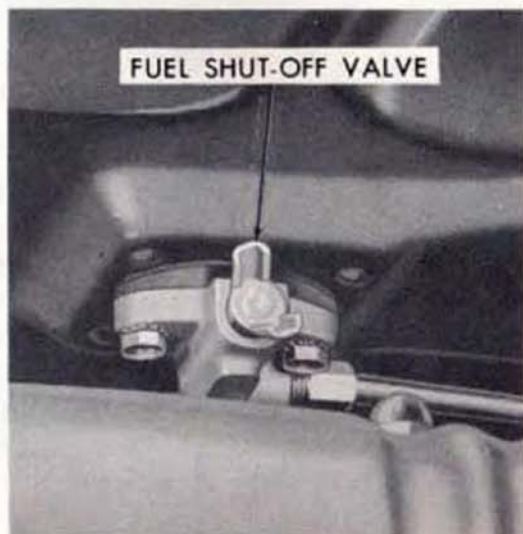

Figure 24
Fuel Shut-Off Valve Assembly

Fuel Injectors: Fuel injectors should be removed, cleaned and tested after every 400 hours of operation. **THIS IS VERY IMPORTANT.** To prevent waste of useful tractor power, we suggest that you contact your Ford Tractor and Implement Dealer when the fuel injectors on your tractor have 400 hours of operating time. Your Ford Tractor and Implement Dealer has access to the special testing and adjusting equipment required for servicing diesel tractor injection systems. See Figure 29.

SERVICE EVERY 600 HOURS

Front Wheel Bearings: Clean the front wheel bearings thoroughly with a solvent and repack with (M-4664) short fibre grease. Lubricate the spindle shaft before replacing the bearings.

Select-O-Speed Transmission: In order to assure peak transmission operation and smooth shifting characteristics, it is important that you have your Ford Dealer adjust the transmission bands at this time.

Hydraulic System: After the first 50 hours and after every 600 hours operation, change the oil in the hydraulic system. In winter, operate the system to thin the oil before draining. Clean the fill port carefully before removing to prevent dirt from entering the system. Fill the system with 8 quarts of M-4864-A or M2C41 hydraulic oil at temperatures above 10° F. At temperatures below 10° F., use 6 quarts of M-4864-A or M-2C41 and 2 quarts of M-4864-D hydraulic oil.

Transmission: Change the transmission oil at the 50 hour inspection and every 600 hours of operation thereafter. In winter operate the tractor to thin the oil before draining. Fill the 4 speed transmission with 6½ quarts of mild extreme pressure lubricant and the 5 speed transmission with 8½ quarts. Use mild extreme pressure lubricant SAE 80, both summer and winter.

Rear Axle: Replace the oil in the rear axle after the first 50 hours of operation and following every 600 hours thereafter. In winter, operate the tractor to thin the oil before draining. Refill Series 601-D axles with 8 quarts of oil, and Series 801-D axles with 11½ quarts. Use mild extreme pressure lubricant SAE 80, both summer and winter.

SERVICE EVERY 1200 HOURS

Select-O-Speed Transmission: After the first 50 hours and every 1200 hours of operation thereafter, change the transmission oil and use Ford M-2C41 lubricant for replacement.

NOTE: The tractor rear wheel bearings are sealed and require no further lubrication for the life of the tractor.

LUBRICATION

EVERY 10 HOURS

- 15 CRANKCASE VENTILATING SYSTEM—Clean and Oil
 - 5 AIR CLEANER—Clean and Oil
 - 14 CRANKCASE DIP STICK—Check Oil Level
 - 19 HYDRAULIC SYSTEM DIP STICK—Check Oil Level
- LUBRICATE PRESSURE FITTINGS BELOW:
- 2 DRAG LINKS (FRONT)
 - 26 POWER STEERING CYLINDER
 - 4 SPINDLE PINS
 - 17 DRAG LINKS (REAR)
 - 8 CLUTCH PEDAL
 - 21 LEVELING BOX

TOP VIEW OF TRACTOR

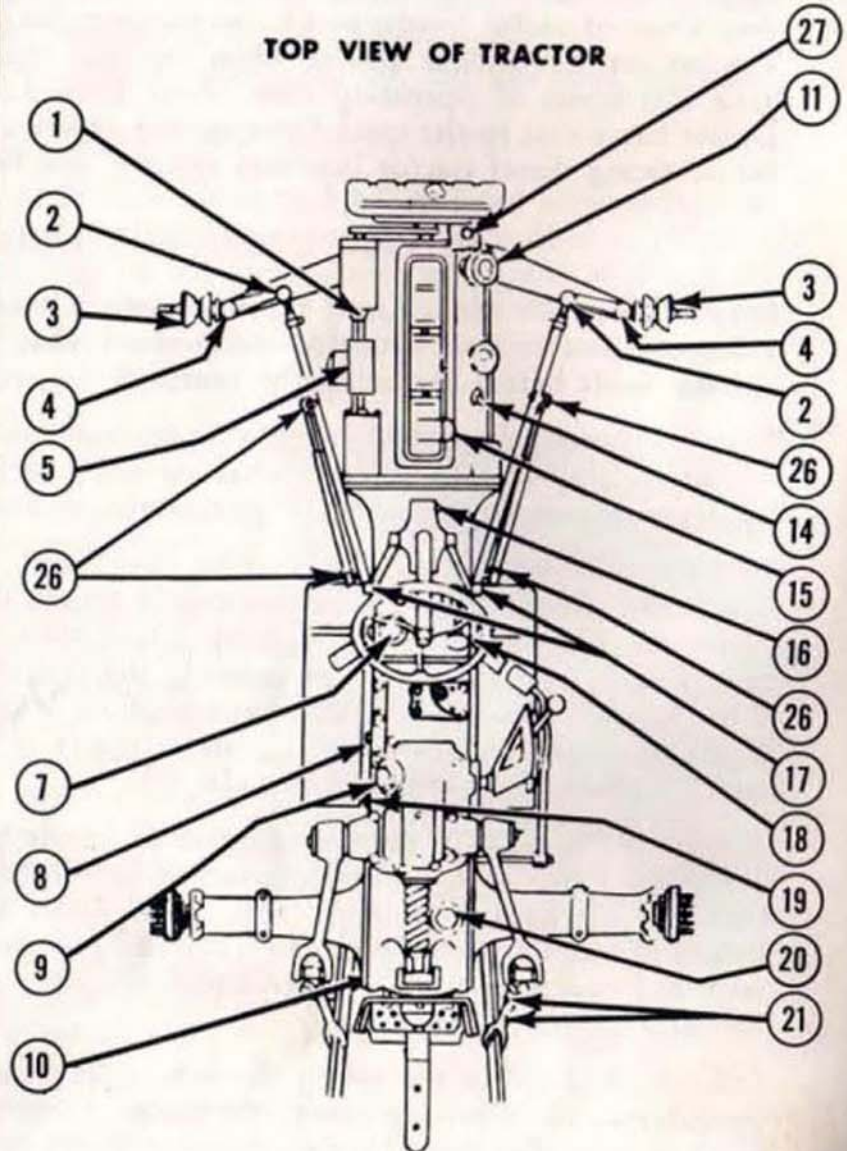

EVERY 100 HOURS

- 27 PUMP RESERVOIR—Check Oil Level and Replenish with Automatic Transmission Fluid—Type "A" or oil meeting Ford specifications M-2C41.
- 22 ENGINE CRANKCASE—Drain and Refill: and Winter (Below 32° F.) S.A.E. 10—10W
- 11 Summer (Above 32° F.) S.A.E. 20 or 30
- 10 REAR AXLE—Check Oil at Level Plug on and Side of Housing and Add Oil if
- 20 Necessary.
- 18 4-SPEED TRANSMISSION—Check oil and at level plug on side of housing and add 7 oil if necessary.
- 28 SELECT-O-SPEED TRANSMISSION—Check oil at level and filler plug on side of housing and add oil, if necessary. (Use only M-2C41 Ford Universal Hydraulic Lubricant.)
- 16 STEERING HOUSING—Check Oil Level.

Figure 25

CHART

UNDERSIDE VIEW OF TRACTOR

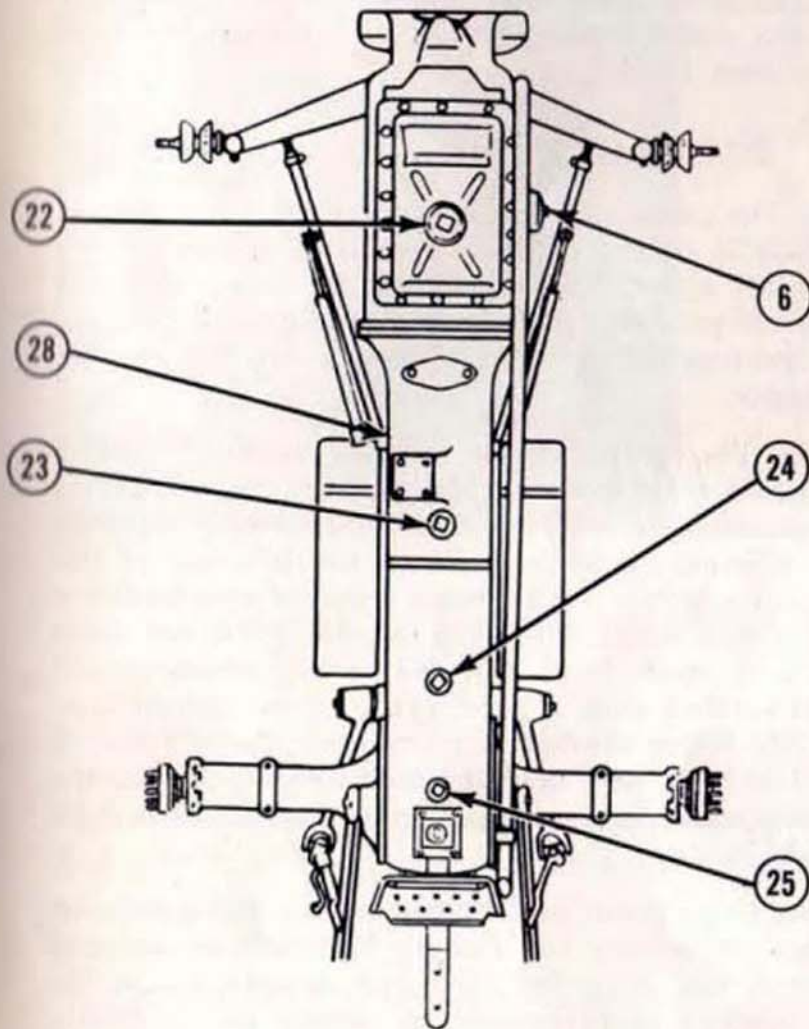

EVERY 600 HOURS

- 3 FRONT WHEEL BEARINGS**—Repack with High Grade Short Fibre Grease (Ford Spec. M4664)
- 23 4-SPEED TRANSMISSION**—Drain and Refill (Use Mild Extreme Pressure Lubricant SAE 80, Both Summer and Winter)
- 7**
- 24 HYDRAULIC SYSTEM**—Drain and Refill (Below 10° F.—Mix 6 Qts. M-4864-A with 2 Qts. M-4864-D) (Above 10° F.—8 Qts. M-4864-A) or 8 Qts. M-2C41 at any temperature
- 9**
- 25 REAR AXLE**—Drain and Refill (Use Mild Extreme Pressure Lubricant SAE 80, Both Summer and Winter)
- 20**

EVERY 1200 HOURS

- 28 SELECT-O-SPEED TRANSMISSION**—Drain and refill after the first 50 hrs. and every 1200 hrs. thereafter. Use M-2C-41 summer and winter.

EVERY 200 HOURS

- 6 OIL FILTER**—Replace every other engine oil change and add one quart of oil to fill new cartridge.
- 1 GENERATOR**—Oil rear bearing with light oil. Do not over lubricate.

EVERY 400 HOURS

- FUEL FILTER**—Replace element.
- FUEL INJECTORS**—Clean and test.

Figure 26

MECHANICAL MAINTENANCE

In addition to lubrication services, regular mechanical maintenance is necessary to keep your tractor performing at maximum efficiency. The information in this section has been prepared to help you perform certain routine jobs on your tractor. Avoid breakdowns during the busy seasons by checking these items frequently and making the necessary repairs or adjustments. For major repair work or service parts, see your Ford Tractor and Implement Dealer.

COOLING SYSTEM

Radiator Pressure Cap: The cooling system on your Ford Tractor operates under pressure which is controlled by the radiator cap. Keep the cap installed tightly at all times. Caution should be exercised when removing the cap to prevent possible injury from escaping steam. Always remove the cap when draining the radiator. If lost, a new cap may be purchased from your dealer.

Cleaning and Protection: The cooling system should be drained, flushed and refilled with clean, soft water every spring. Remove the thermostat prior to the flushing operation. Drain the system by removing the plug at the bottom of the radiator, the drain cock on the left side of the cylinder block and the radiator cap. Add a good grade of rust inhibitor when refilling the system with water. Open the radiator grille and clean the radiator fins with a wire brush. In the fall, the cooling system should be drained, flushed and refilled with a good grade of permanent type anti-freeze. Alcohol is not recommended as protection against freezing because it starts to boil at 170° and during heavy duty operation, the tractor may operate at temperatures above this figure. Anti-freeze may be purchased from your local dealer.

NOTE: The United States Department of Commerce, National Bureau of Standards and the American Society for Testing Materials recommend that antifreeze be drained and discarded after one season's use as the corrosion inhibiting properties of permanent anti-freeze will normally be depleted.

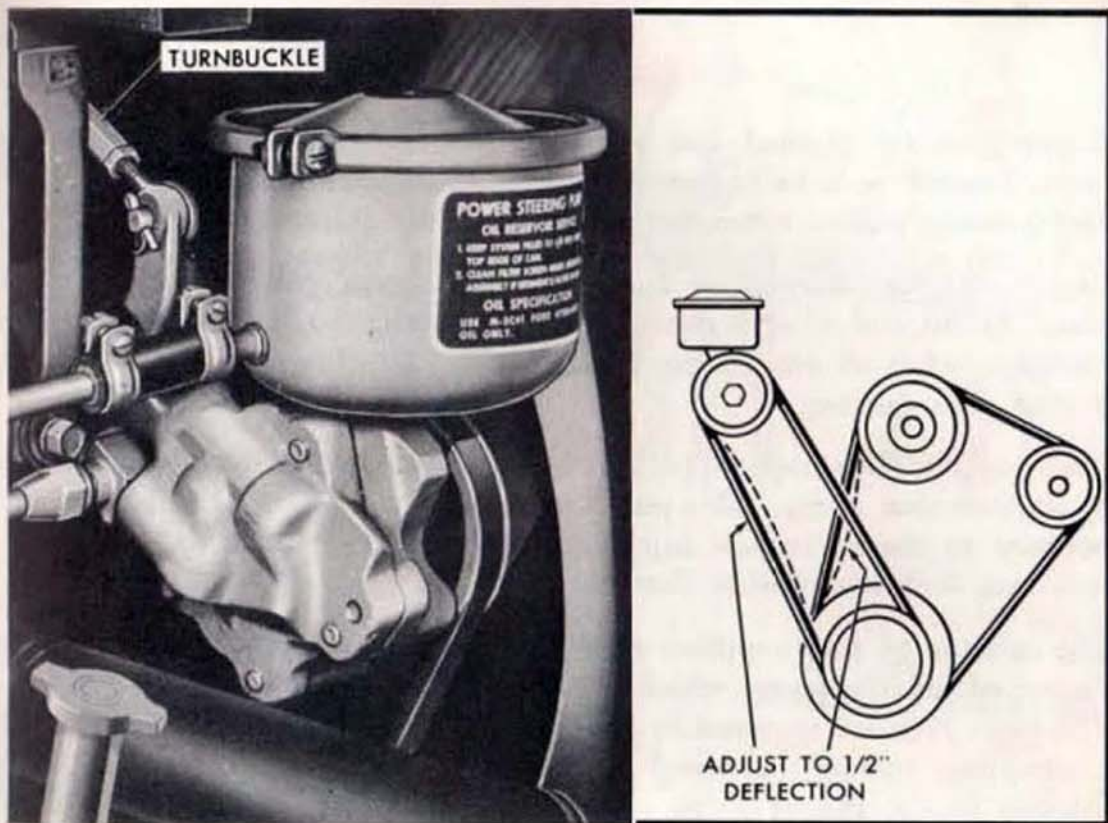

Figure 27
Adjusting Fan, Generator and Power Steering Pump Belts

Power Steering Pump Drive Belt: The power steering pump is driven by a belt from the crankshaft pulley. Check this belt periodically for proper tightness. Adjust the belt tension by loosening or tightening the turnbuckle until a $\frac{1}{2}$ inch belt deflection is obtained with normal pressure at belt center as shown in Figure 27.

Thermostat: The thermostat automatically regulates the temperature within the cooling system by controlling the flow of coolant through the radiator. It should start to open at 177 to 182 degrees and be fully open at 197 to 202 degrees. If the thermostat does not function properly, it should be replaced.

Water Pump and Fan Belt: The water pump is driven by the fan belt. Check the belt periodically for proper tightness. Adjust the tension by loosening the two generator pivot bolts and the belt tension adjusting bolts. Move the generator in or away from the engine until a $\frac{1}{2}$ inch belt deflection is obtained with normal thumb pressure as shown in Figure 27, and tighten the bolts.

FUEL SYSTEM

When properly cleaned and adjusted, the air and fuel system on the Ford Tractor will help provide maximum power and smooth engine performance with a minimum amount of fuel consumption.

Fuel Tank: Use only clean fuel which has been stored in a dry, cool place. At the end of each day of operation, refill the fuel tank to remove moisture laden air and reduce condensation. This is extremely important during cold weather.

Fuel Supply: The fuel supply to the combustion chamber is controlled by an injection pump. This pump meters and distributes the fuel under pressure to the individual injectors, which in turn spray (atomize) the fuel into each combustion chamber.

The volume of fuel supplied to the engine is controlled by a metering device within the pump which is activated by the governor mechanism. The high pressure required to operate the injectors is created by internal mechanisms within the pump and the distribution of the fuel to each injector in the proper firing order is controlled by the relationship of the various passages within the pump. The injection pump is driven by the engine camshaft.

Diesel Fuel Storage: The tolerances of the closely fitted injector components and fuel injection pump parts are held within millionths of an inch, so it is vitally important that they be kept free from the damaging action of minute particles of dirt that may enter the fuel—particularly during fuel handling or storage. See Figure 28.

Proper handling and storage of diesel fuels can help you to avoid costly repair bills on the fuel injection system of your tractor. Store diesel fuel in black iron tanks or containers. Galvanized tanks should never be used. Let the fuel settle at least 12 hours before use. This will permit any sediment or water in the fuel to settle to the bottom of the container. Use the largest container possible for the storage of fuel and keep the container as full as possible to avoid condensation.

If you are not using a filter on your storage tank, it is recommended that a funnel equipped with a 100 mesh screen be employed when filling your tractor fuel tank. A chamois skin will do the job if a mesh screen funnel is not available.

NOTE: The micron filter fitted in the fuel line of your tractor serves to remove occasional foreign material in the fuel, but it will not be sufficient to handle the volume of dirt caused by improper storage and handling. Change this filter every 400 hours or at least every 6 months.

Install your storage container above the ground and tilt the tank so the discharge outlet is on the highest end of the tank. Provide a drain plug at the lowest point of the tank so that moisture and sediment can be drained off periodically. Install a suitable filter on the discharge outlet of the storage container.

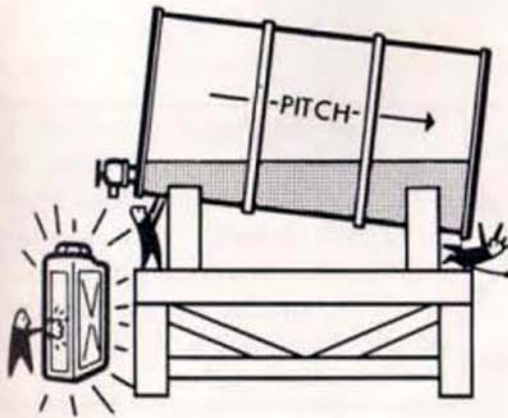
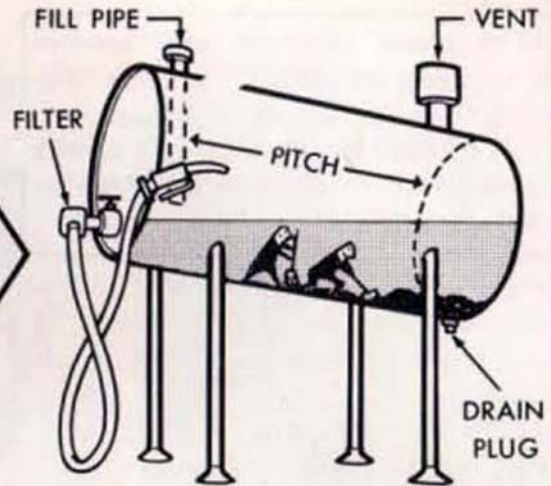

A 50 gallon drum makes a suitable container for diesel fuel, provided that it is tilted on the stand. The drum should be *cleaned and flushed* before each refilling.

Figure 28
Diesel Fuel Storage

With clean injectors and normal fuel pressure (2700 pounds per square inch) only a small percentage of your tractor engine's power is required to operate the fuel injection pump.

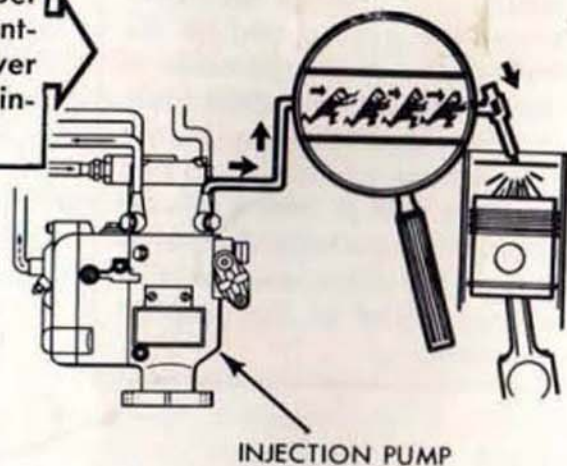

But...

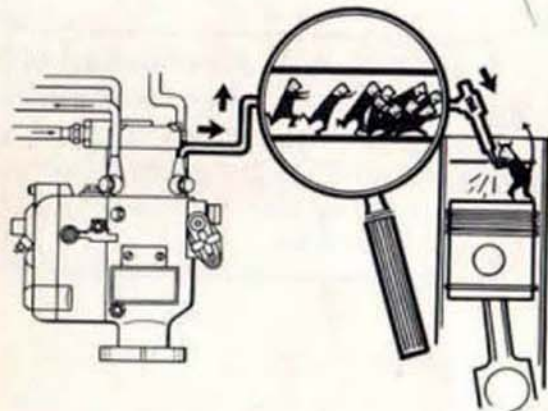

Dirty or improperly adjusted fuel injectors can contribute to a fuel pressure build-up as high as 7500 pounds per square inch in the injection lines . . . requiring an increased amount of the engine power to drive the injection pump.

This means loss of injector efficiency and loss of engine power! Power and efficiency that could be utilized for useful work. Greater fuel consumption and the possibility of worn or broken parts occur due to the additional load exerted on the pump.

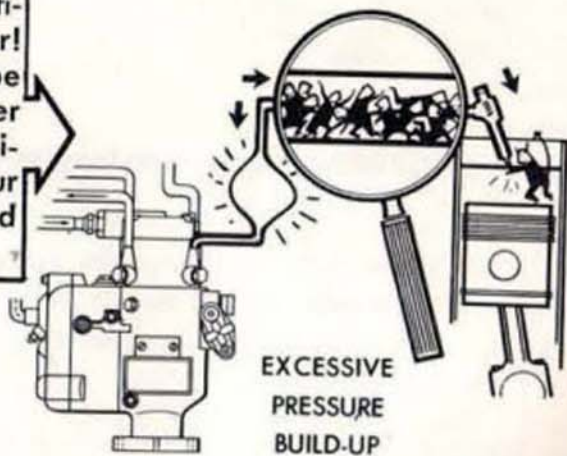

Figure 29
Fuel Injector Maintenance

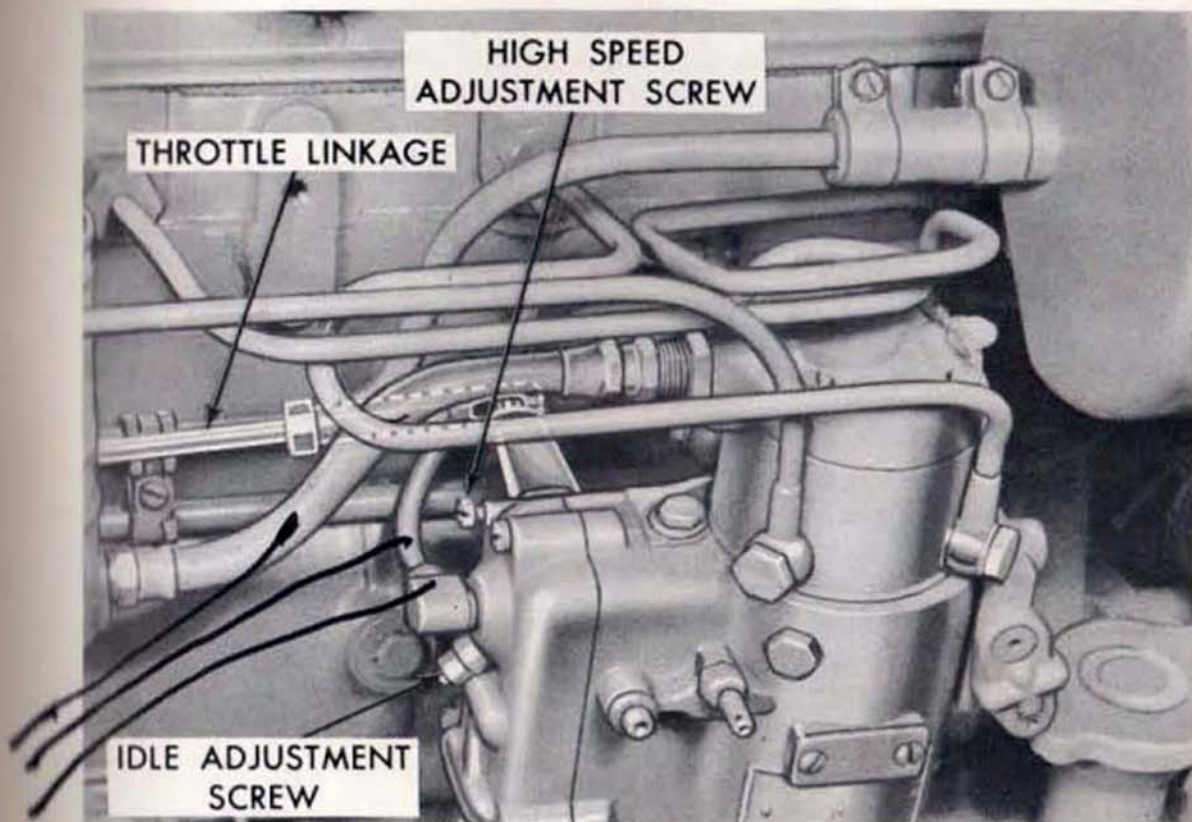

Figure 30
Idle and High Speed Adjustments

FUEL SYSTEM ADJUSTMENTS

The fuel injection pump is provided with an engine idler adjusting screw and high speed adjusting screw shown in Figure 30. In addition, the throttle linkage may be adjusted to provide for the correct amount of dead travel for the hand throttle lever. Each of these adjustments is important to the operating efficiency of the diesel tractor and should be checked whenever the tractor is serviced.

Idler Speed Adjustment: With the hand throttle in the idle position and the engine at the normal operating temperature of 180° back off the jam nut $\frac{1}{4}$ turn on the pump idle speed adjusting screw and adjust the screw for an idle speed of 675 rpm. Using an Allen wrench, turn the screw in to increase engine rpm and out to decrease engine rpm. After the correct idle speed has been obtained, lock the screw in position with the jam nut.

DO NOT TURN THE IDLE ADJUSTING SCREW OUT ANY MORE THAN NECESSARY TO DECREASE THE ENGINE RPM THE REQUIRED AMOUNT. IF THE SCREW IS BACKED OUT OF THE GOVERNOR COVER, THE IDLE CONTROL WITHIN THE PUMP WILL FALL FROM PLACE AND THE PUMP MUST THEN BE REMOVED FROM THE TRACTOR AND RETURNED TO YOUR DEALER FOR SERVICE.

Throttle Linkage Adjustment: The linkage should be checked for proper length in relation to the hand throttle lever dead travel at the idle position, when making normal service adjustments for engine speed.

With the engine running, set the hand throttle lever to the idle stop and disconnect the throttle linkage at the injection pump operating lever. Rotate the pump operating lever rearward to its idle position.

NOTE: There is no idle stop on the pump operating lever. When it is at idle position, a slight drag will be felt. When the lever is moved further to override this drag, it contacts the stop and shuts off the fuel.

With the pump operating lever in idle position, adjust the throttle linkage by loosening the lock nut and by turning the ball cage until it aligns with the ball on the pump operating lever. Reconnect the linkage and check for idle speed of 675 rpm with the hand throttle lever against the idle stop. Adjust the idle speed setting at the pump if a correction is required. See "Idle Speed Adjustment." Move the hand throttle lever off of its stop, about $\frac{1}{4}$ " to $\frac{1}{2}$ " (measured at the hand throttle lever). The engine should just start to pick up speed at this position, which insures a small amount of dead travel in the hand lever throttle before the engine accelerates.

Repeat the linkage adjustment until the hand throttle lever dead travel is established.

NOTE: The dead travel is entirely controlled by the length of the throttle linkage and must be obtained to prevent activating the pump governor in low idle range.

High Speed Adjustment: With the hand throttle in the full throttle position and the engine at the normal operating temperature of 180° , back off the jam nut on the pump operating lever stop screw. Adjust the screw for a Proof-Meter reading of 2430 rpm with the Select-O-Speed Transmission tractor and 2230 rpm with the four-speed transmission tractor. Using a screwdriver, turn the screw out to increase engine rpm and in to decrease engine rpm. After the proper adjustments have been made, lock the screw in position with the jam nut.

Pump to Engine Timing: Remove the timing window cover and gasket on the fuel injection pump and rotate the engine until the timing marks align as shown in Figure 31. Remove the engine flywheel timing cover and check the flywheel degree marking which should read 18° BTDC on all Series 801-D tractors and 26° BTDC on all 601-D tractors. If it does not, adjustment will have to be made.

To adjust, use a screwdriver on the flywheel ring gear to reverse the engine approximately 15° BTDC. Return the flywheel position back to the correct marking as outlined above. This procedure will insure that

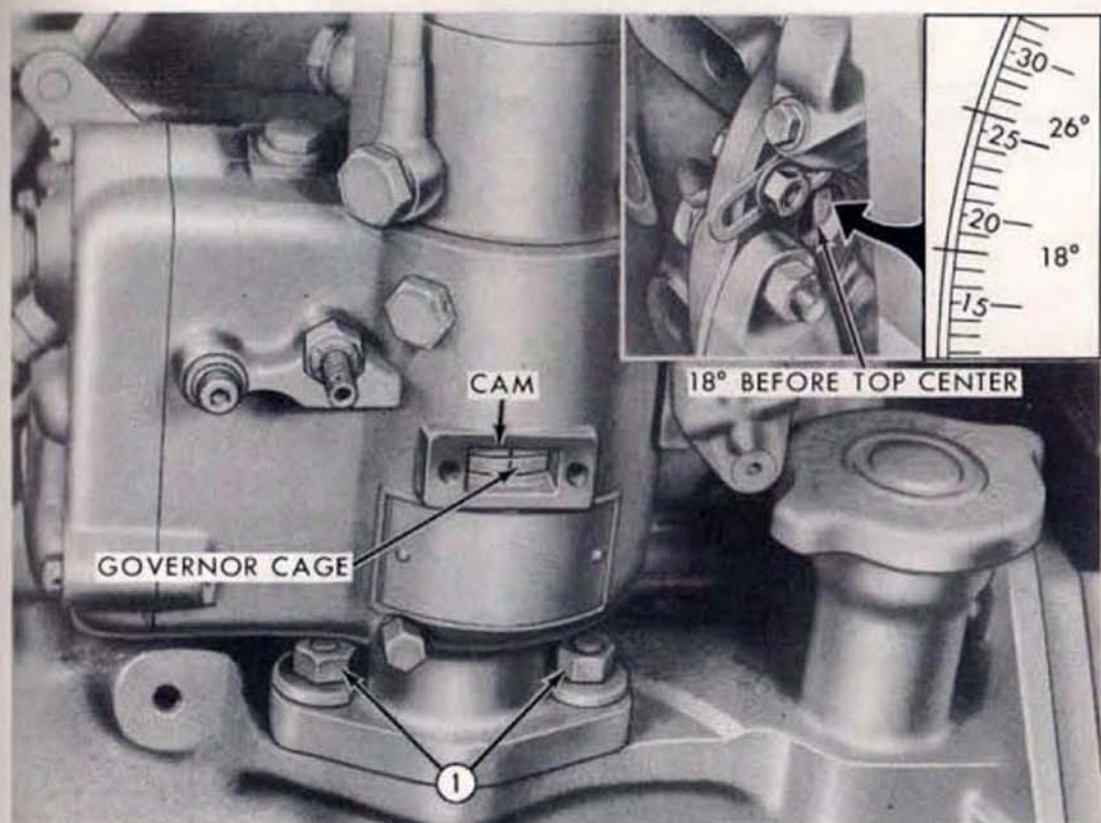

Figure 31
Pump to Engine Timing

the backlash is removed from the pump drive. Loosen the pump housing at (1), Figure 31, and rotate the pump assembly until the timing marks align. Re-tighten the pump assembly nuts. Check the timing by rotating the engine until the alignment marks again align. If the proper timing has not been obtained, repeat the process.

Replace the engine timing cover and the pump timing window cover and gasket.

ELECTRICAL SYSTEM

The 12-volt electrical system of the Ford Diesel Tractor, as compared to the 6-volt system of the Ford Gasoline Tractor, doubles the available voltage and doubles the power of the electrical supply system.

The system is grounded through the battery negative post—not the positive post as in the gasoline tractor 6-volt system.

Poor electrical connections are more likely to cause trouble in a 12-volt than in a 6-volt system. Any current leakage is twice as likely to discharge a 12-volt battery.

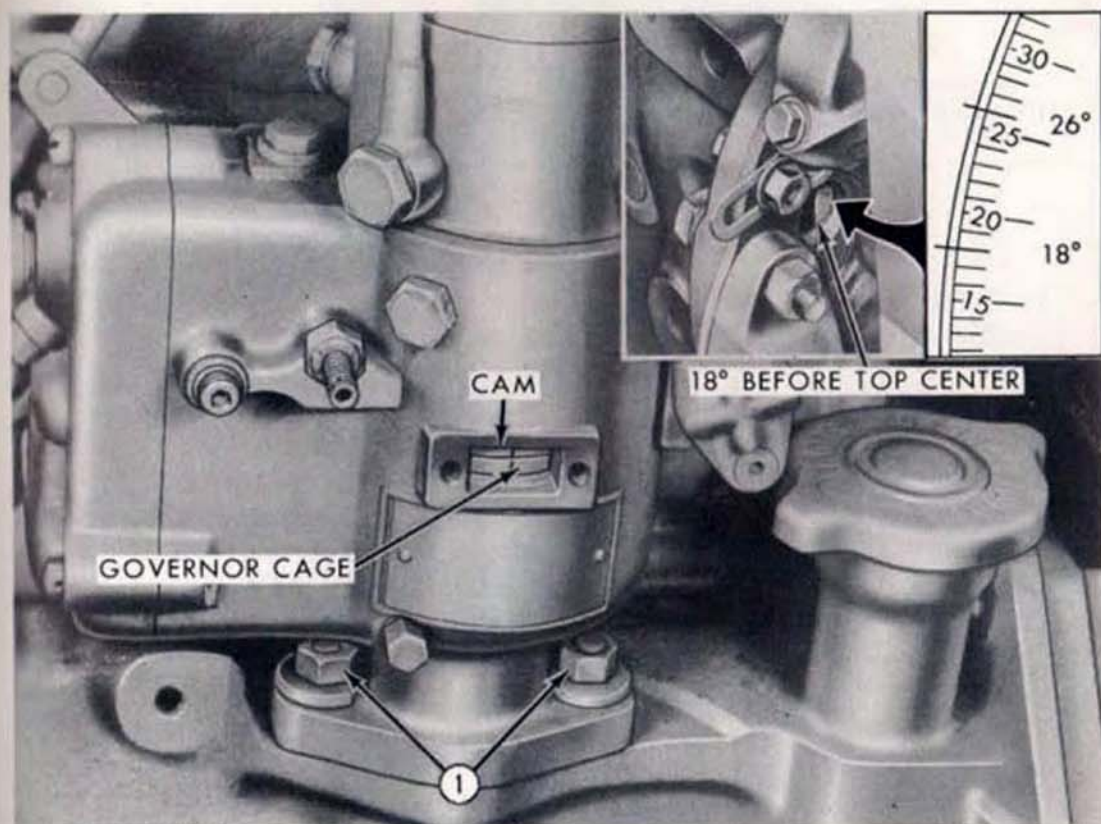

Figure 31
Pump to Engine Timing

the backlash is removed from the pump drive. Loosen the pump housing at (1), Figure 31, and rotate the pump assembly until the timing marks align. Re-tighten the pump assembly nuts. Check the timing by rotating the engine until the alignment marks again align. If the proper timing has not been obtained, repeat the process.

Replace the engine timing cover and the pump timing window cover and gasket.

ELECTRICAL SYSTEM

The 12-volt electrical system of the Ford Diesel Tractor, as compared to the 6-volt system of the Ford Gasoline Tractor, doubles the available voltage and doubles the power of the electrical supply system.

The system is grounded through the battery negative post—not the positive post as in the gasoline tractor 6-volt system.

Poor electrical connections are more likely to cause trouble in a 12-volt than in a 6-volt system. Any current leakage is twice as likely to discharge a 12-volt battery.

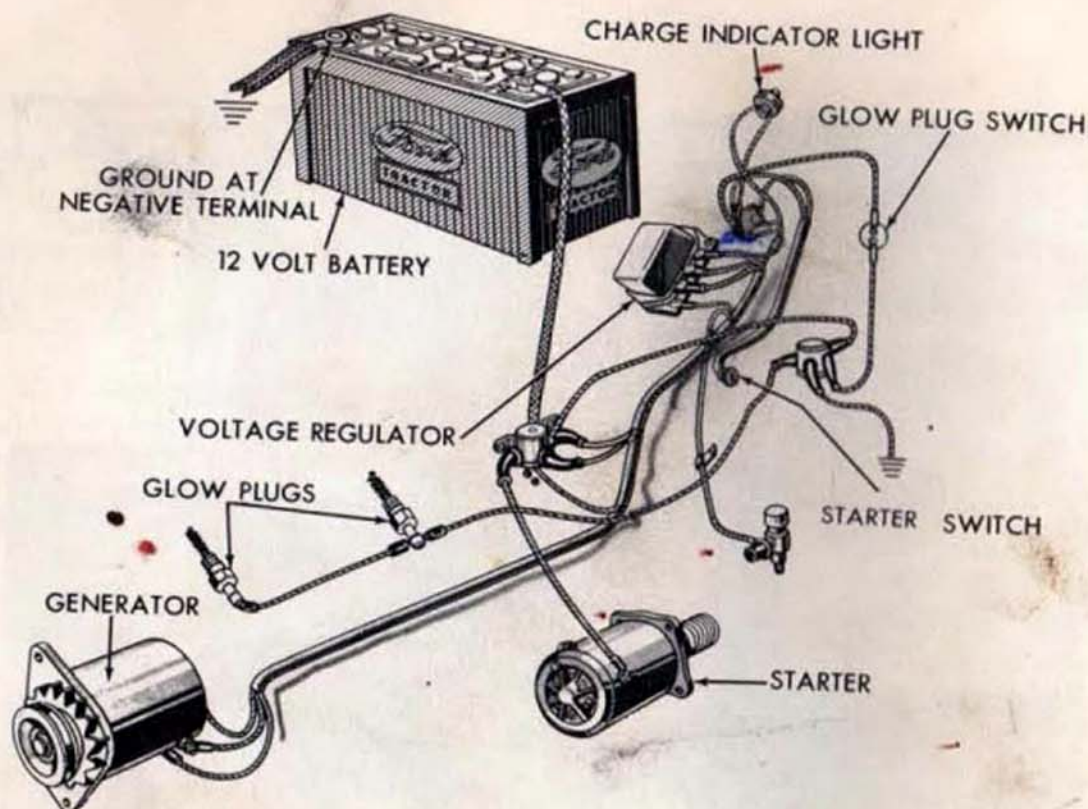

Figure 32
Diesel Tractor Electrical System

Generator: The maximum charging rate of the generator is 20 amperes at 1500 engine rpm. The generator is driven by the fan belt. For belt adjustment, refer to "Water Pump and Fan Belt," under COOLING SYSTEM.

If the generator will not charge, check the condition of the wires in the generating circuit. See Figure 32. Make sure all connections are clean and tight.

Battery: The level of electrolyte in the 12-volt battery should be checked at least twice each month and distilled water added if necessary. Battery terminals should be kept tight and free of corrosion. Two tablespoons of baking soda mixed with a pint of water will make a good solution for cleaning corroded terminals and the battery case. After cleaning, the battery should be washed with clean water. An application of petroleum jelly on the terminals will counteract corrosion.

An important point to remember is that a 12-volt battery will not cease cranking the engine until the battery is almost completely discharged. In this condition, the electrolyte is nearly pure water. It will freeze at just under 32° F., and a cracked battery case may result. It is advisable to have the battery checked more frequently in cold weather to be sure it is fully charged. The specific gravity of the electrolyte indicates the

amount of battery charge. The amount of charge, with respect to specific gravity of the electrolyte, is shown in the following chart:

State of Charge	Specific Gravity Temperate Climates	Specific Gravity Tropical Climates
Fully Charged	1.280	1.225
75%	1.230	1.180
50%	1.205	1.160
25%	1.170	1.135
Discharged	1.110	1.080

ENGINE

Valve Clearance: One of the most important factors governing good engine performance is that of correct valve tappet clearances. On a new tractor, correct clearances are set before the tractor leaves the factory and are checked again by your dealer at the pre-delivery inspection. It is recommended, however, that the valve clearance be checked every 250 hours of tractor operation.

To set valve clearance, run the engine until normal operating temperature is reached. Stop the engine and remove the rocker shaft cover. Tappets can only be adjusted properly when the valve is fully closed. It will be necessary to crank the engine with the starter to allow valves to close when making adjustments.

To adjust the tappets, turn the valve rocker arm adjusting screw in the desired direction. The correct valve tappet clearance is .014 to .016 with the engine hot.

Valve Grinding: One of the factors involving good engine performance is absolute sealing of the combustion chamber by the valves and rings against compression losses. Valves and valve seats of modern engines are so hard that it is impossible to obtain a satisfactory valve reconditioning job by hand grinding. A good valve job is so important to engine performance that we recommend having your dealer perform this work whenever it becomes necessary.

Clutch: To obtain proper operation and to insure a longer clutch life, on 4-Speed Transmission equipped tractors, it is necessary to maintain the recommended clutch pedal free travel. Free travel is the distance the clutch pedal can be pushed down before resistance is met.

To adjust pedal free travel, loosen the lock nut and turn the pedal free travel adjusting screw in to increase free travel or out to decrease free travel. Set the pedal free travel at $1\frac{1}{2}$ ". Make sure the lock nut is securely tightened at all times.

To insure proper clutch disengagement, it is necessary that the pedal be positioned to 7" above the running board. Adjustment is made by lengthening the clutch release rod to decrease height and shortening the rod to increase height.

amount of battery charge. The amount of charge, with respect to specific gravity of the electrolyte, is shown in the following chart:

State of Charge	Specific Gravity Temperate Climates	Specific Gravity Tropical Climates
Fully Charged	1.280	1.225
75%	1.230	1.180
50%	1.205	1.160
25%	1.170	1.135
Discharged	1.110	1.080

ENGINE

Valve Clearance: One of the most important factors governing good engine performance is that of correct valve tappet clearances. On a new tractor, correct clearances are set before the tractor leaves the factory and are checked again by your dealer at the pre-delivery inspection. It is recommended, however, that the valve clearance be checked every 250 hours of tractor operation.

To set valve clearance, run the engine until normal operating temperature is reached. Stop the engine and remove the rocker shaft cover. Tappets can only be adjusted properly when the valve is fully closed. It will be necessary to crank the engine with the starter to allow valves to close when making adjustments.

To adjust the tappets, turn the valve rocker arm adjusting screw in the desired direction. The correct valve tappet clearance is .014 to .016 with the engine hot.

Valve Grinding: One of the factors involving good engine performance is absolute sealing of the combustion chamber by the valves and rings against compression losses. Valves and valve seats of modern engines are so hard that it is impossible to obtain a satisfactory valve reconditioning job by hand grinding. A good valve job is so important to engine performance that we recommend having your dealer perform this work whenever it becomes necessary.

Clutch: To obtain proper operation and to insure a longer clutch life, on 4-Speed Transmission equipped tractors, it is necessary to maintain the recommended clutch pedal free travel. Free travel is the distance the clutch pedal can be pushed down before resistance is met.

To adjust pedal free travel, loosen the lock nut and turn the pedal free travel adjusting screw in to increase free travel or out to decrease free travel. Set the pedal free travel at 1½". Make sure the lock nut is securely tightened at all times.

To insure proper clutch disengagement, it is necessary that the pedal be positioned to 7" above the running board. Adjustment is made by lengthening the clutch release rod to decrease height and shortening the rod to increase height.

WHEELS, BRAKES AND TIRES

Front Wheel Toe-in: Front wheel toe-in is set at the factory with precision equipment. The spindles and spindle arms are then chisel marked at the points shown in Figure 33. To align the chisel marks, loosen the clamps at each end of the drag links and adjust as required.

When setting the wheels at the wide position, or when replacing spindles, it will be necessary to realign the wheels. This is done by measuring between the outside of the tire ribs at hub height on both the front and rear of the wheels. Adjust the drag links until the correct toe-in of $\frac{1}{4}$ to $\frac{1}{2}$ inch is obtained.

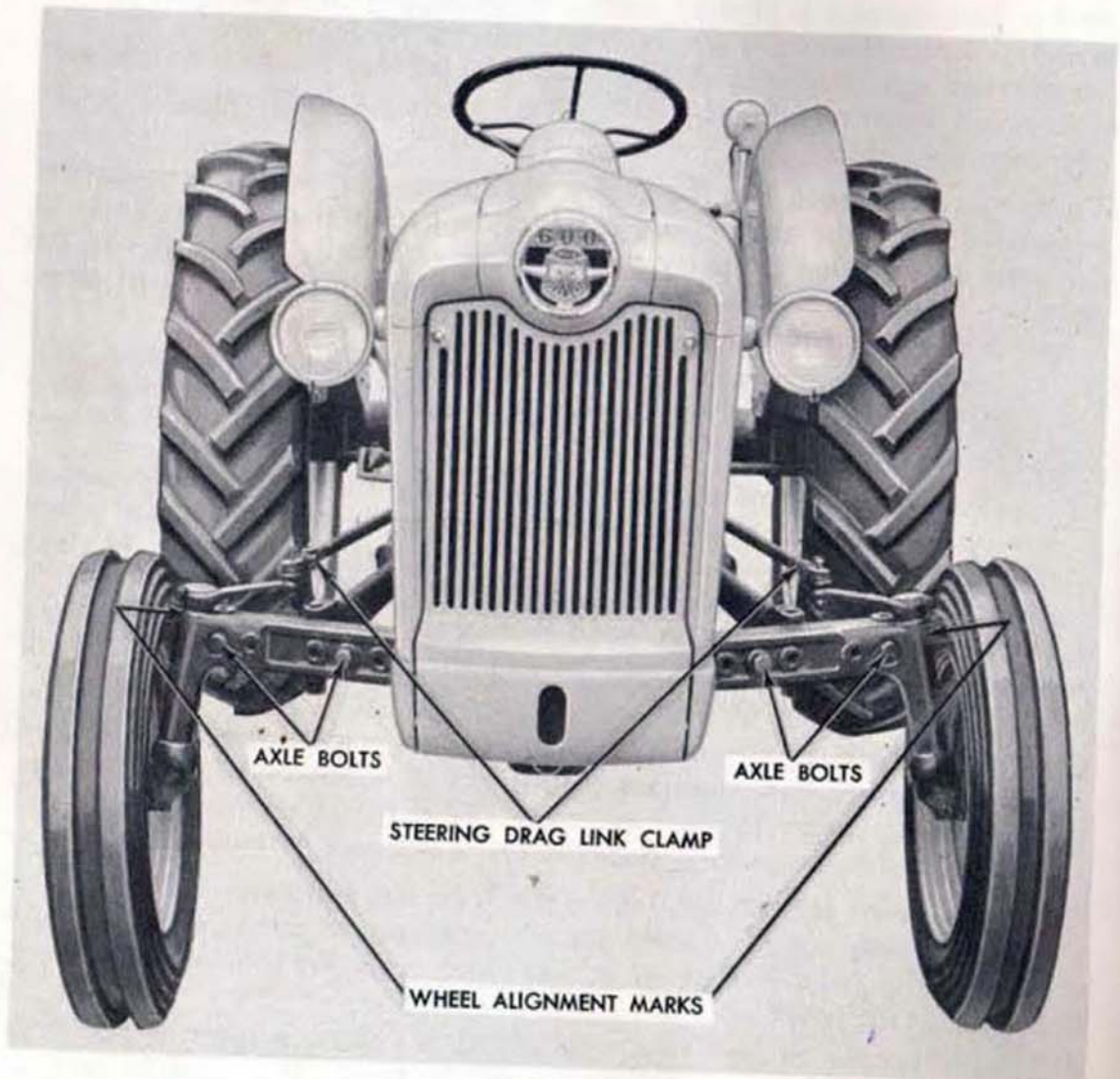

Figure 33
Front Wheel Toe-In Adjustment

Front Wheel Bearings: To adjust the front wheel bearings, raise the front of the tractor with your tractor jack until the wheels rotate freely. Remove the hub cap and the cotter pin which holds the castellated nut and turn the nut until a slight drag is felt. Then back off the nut until the nearest slot in the nut is aligned with the hole in the spindle. Reinstall the cotter pin and hub cap. Pack the bearings with short fibre grease every 600 hours of operation as directed under LUBRICATION, page 34.

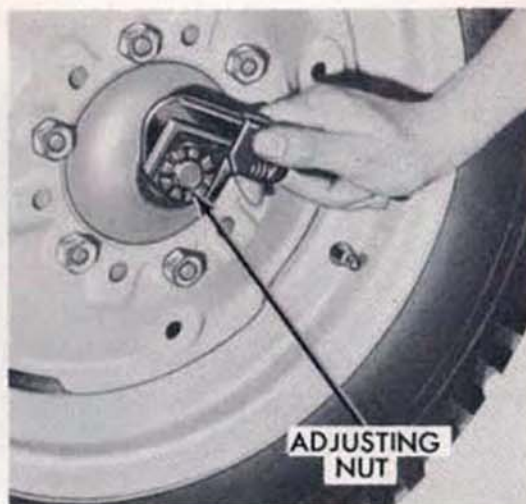

Figure 34

Adjusting Front Wheel Bearings

Brake Adjustment: Jack the tractor up until both rear wheels are free. Remove the adjusting slot cover from the back plate and, with the brake pedals released, turn the adjusting screw clockwise until the brake drags. (See Figures 35 and 36.) Back off the adjusting screw until the brake drags very slightly when the wheel is turned. Adjust the left brake tie rod with the clevis until both brake pedals are in line when both brakes are engaged.

During the first hour of operation after the brakes have been adjusted, check the drums for overheating. If necessary, readjust as outlined above.

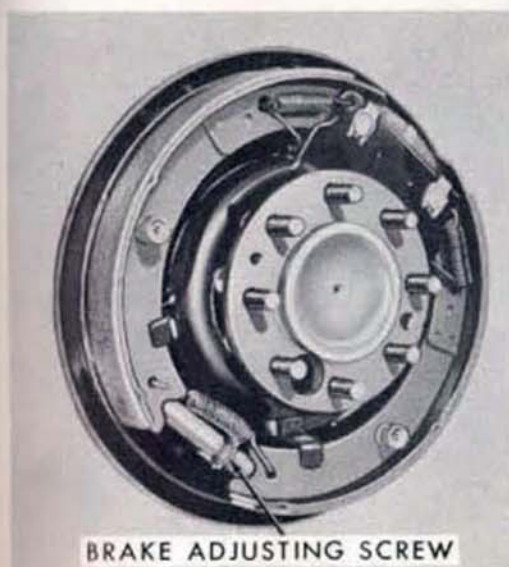

Figure 35

Brake Assembly with Drum Removed

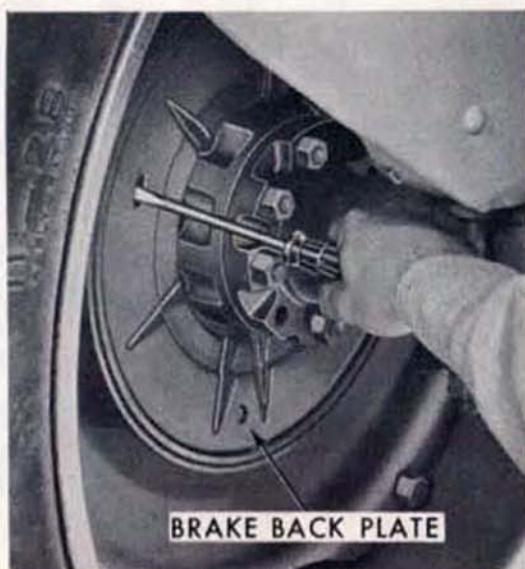

Figure 36

Adjusting the Brakes

Tire Removal: Remove the wheel from the hub and deflate the inner tube completely. Press the valve through the valve hole and loosen both tire beads from the wheel rim, using a tire iron and heavy mallet. With the wheel lying flat, stand on the tire with your feet about 15 inches apart opposite the valve, then force the bead seat into the drop center of the rim.

Insert two tire irons, about 8 inches apart, between the tire bead and the wheel rim near the valve, then pry the bead over the wheel rim. Leaving one tire iron in position, follow around the wheel rim with the other tire iron to remove the remainder of the bead. Remove the inner tube.

Turn the wheel over and block up the disc until the rim is off the floor, as shown in Figure 38. Pry the tire off the rim, starting with a small section and following around the wheel.

Tire Installation: Place the wheel and rim in a flat position. Inflate the inner tube until it is barely rounded out, then install the tube in the tire.

Coat the inside and outside of the tire beads with a soft soap and water solution to protect the bead, then pry the bead over the edge of the rim.

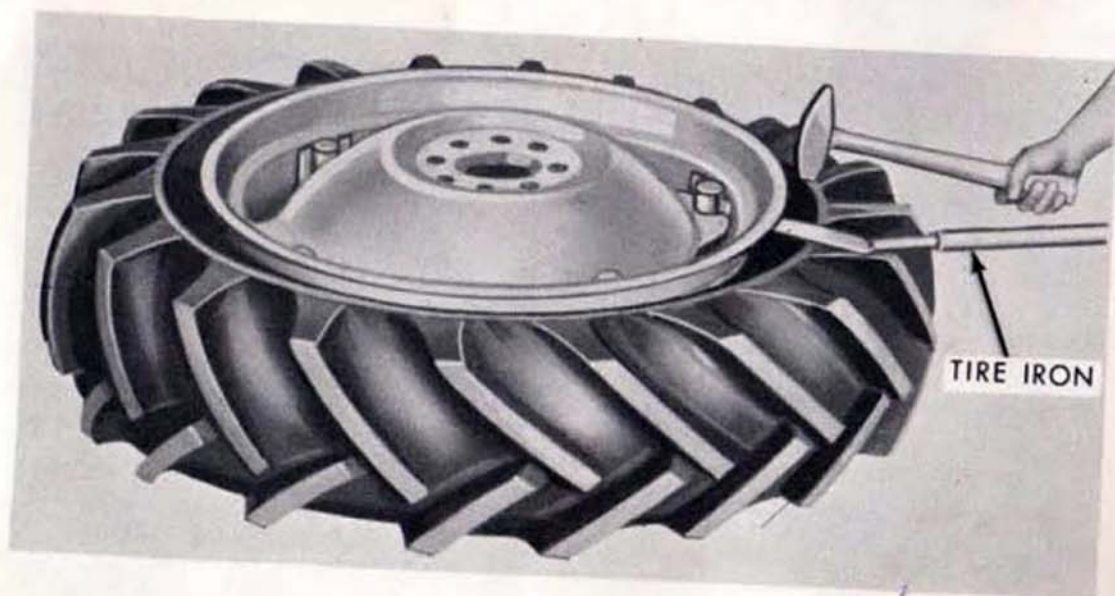

Figure 37
Loosening Tire Bead from Edge of Rim

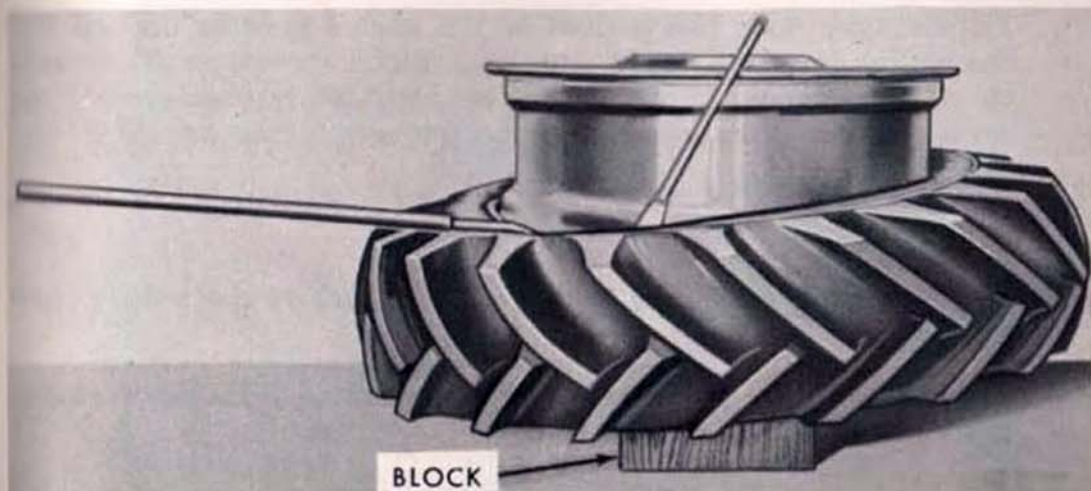

Figure 38
Prying Rim Out of Tire

TRACTOR STORAGE

Tractors which are used seasonally should be protected while in storage. The following operations are suggested:

1. Wash and clean the tractor thoroughly.
2. Use Spray Type Touch-Up Enamel where necessary to avoid rust.
3. Block or tie down the clutch pedal so that the clutch faces are disengaged.
4. Lubricate the tractor, drain and refill transmission, differential, hydraulic system, and engine, as directed under LUBRICATION. Use engine preservative oil in the crankcase to prevent internal corrosion.
5. When the engine is to be stored or removed from operation for an extended period (two months or more) special precautions should be taken to protect the fuel injection pump and injector nozzles against corrosion and gumming during the shutdown period. Before storing, therefore, the fuel system should be flushed with a special oil, a quantity of which will remain in the system when the engine is shut down for storage.

Special diesel engine flushing oils are available from most oil companies. In the event that a special flushing oil is not readily obtainable, a mixture of 50% SAE No. 10W Lube Oil and 50% pure water white kerosene can be substituted. The kerosene must be sulphur free. Your local oil dealer can furnish further information on water white kerosene if necessary.

Fill the tank with two gallons of the special flushing oil and run the engine at normal speed until blue smoke appears in the exhaust to assure complete filling of the fuel injection system. There is no need to remove the injector nozzles for any special handling.

6. Remove the battery and be sure it is fully charged before placing it in storage in a warm place.
7. Place blocking under the tractor axles to remove the weight from the tires.
8. Open drain cocks at bottom of radiator and on left side of engine block to drain the cooling system.
9. Check the tractor for worn or damaged parts. Replace with genuine Ford Tractor parts.

Tractors which have been placed in storage should be completely serviced in the following manner before putting into use.

1. Inflate the tires to recommended pressure; fill cooling system (use corrosion inhibitor in warm weather, anti-freeze in winter), fill fuel tank; check oil level in crankcase, rear end, transmission, and air cleaner, and install fully charged battery.
2. Start the engine and let it idle a few minutes. Be sure the engine is receiving lubrication and that each control is functioning correctly.
3. Drive the tractor without a load to be sure it is operating satisfactorily.

SAFETY PRECAUTIONS

1. Do not permit anyone to ride on the tractor with the operator.
2. The operator should never leave the tractor seat when the tractor is in motion.
3. Use care when operating on steep grades to maintain proper stability.
4. Always drive tractor at speeds slow enough to insure safety, especially when operating over rough ground, near ditches or turning.
5. Keep the tractor in gear when going downhill, however, do not shift to coasting gears when using the Select-O-Speed transmission as a brake.
6. Always shut off the engine when leaving the tractor.
7. Make sure the brake pawls are set when parking the tractor.
8. Always keep the tractor brakes in proper operating condition.
9. Do not refuel the tractor when the engine is overheated or running.
10. Keep the tractor keys where they are not available to children.
11. Remember, a careful operator always is the best insurance against an accident.

ACCESSORIES

A wide variety of accessories, attachments and special items are available for use on your new Row Crop Ford Diesel Tractor.

These are designed to make your farm work easier by providing you with maximum convenience and operating comfort. In many cases, they will improve the performance of your Ford Tractor and Equipment. All of the accessories, attachments and special items listed in this section are available at extra cost from your Ford Tractor and Implement Dealer. For a more detailed description of these items, see your "Ford Tractor Accessories" Booklet included in your owner's envelope.



Be safe, be seen, use lights at night.

FORD TRACTOR ACCESSORIES AND SPECIAL ITEMS

SERIES 601-D and 801-D

TRACTOR ACCESSORIES

- Bumper Assembly (Push or Pull Type)
- Dry Charge Battery
- Dual Rear Wheel Kits
- Grease Gun and Bracket
- Implement Lamp Kit
- Implement Warning Lamp Kit
- Power Adjusted Rear Wheels
- PTO Belt Pulley Assembly
- PTO Shield
- Remote Control Attachments
- Rest-O-Ride Tractor Seat—*Standard on 801-D Series All Purpose Tractors*
- Stabilizer Bars
- Tire Pump and Gauge
- Tractor Half Cab
- Horizontal Exhaust Kit
- Wheel Weights—Rear—Heavy Duty—*For 801-D Series Tractors Only*
- Wheel Weights—Rear—Regular Duty
- Wheel Weights—Front
- Manifold Heater Kit

SPECIAL ITEMS

A complete line of chemicals, hydraulic oils, starting fluid and oil additives plus paints are available. For further details see your Ford Tractor and Implement Dealer.

SPECIFICATIONS

The specifications on the following pages are provided for your information and reference. For further information see your local Ford Tractor and Implement Dealer.

The Ford Motor Company reserves the right to make changes in specifications or to add improvements at any time without notice or obligation.



Be Safe—be careful at all times.

SPECIFICATIONS

FORD ALL PURPOSE AND SPECIAL UTILITY TRACTORS

SERIES 601-D & 801-D

GENERAL

Wheelbase @ 52" Tread Width.....	74.5 inches
Over-all Length @ 52" Tread Width.....	Series 601-D—120.83 inches Series 801-D—120.83 inches
Over-all Width @ 52" Tread Width.....	63.9 inches
Front Tread Width.....	All Purpose Tractors—52 to 76 inches
Rear Tread Width.....	All Purpose Tractors—52 to 76 inches
Front Tread Width.....	Special Utility Tractors—52 to 76 inches
Rear Tread Width.....	Special Utility Tractors—52 to 76 inches
Rear Tread Width.....	Power Adjusted Wheels—56 to 84 inches
Crop Clearance	21 inches (approx.)
Turning Circle Diameter (with brakes).....	18 feet 1 inch
Shipping Weight (Approx.)	
Series 601-D	2840 lbs.
Series 801-D	3008 lbs.

Tire Size:

Front—Standard	Series 601-D—5:50 x 16—4 ply Series 801-D—6:00 x 16—4 ply
Rear—Standard	Series 601-D—11:00 x 28—4 ply Series 801-D—12:00 x 28—4 ply
Rear—Standard.....(Special Utility Tractors only)	—10:00 x 28—4 ply
Rear—Optional	all models—13:00 x 24—4 ply all models—14:00 x 24—6 ply

CAPACITIES

Fuel Tank.....	Series 601-D—13 U.S. gallons (10.83 Imperial gals.) Series 801-D—17 U.S. gallons (14.16 Imperial gals.)
Cooling System	15 U.S. quarts (12.5 Imperial qts.)
Crankcase (including filter).....	5 U.S. quarts (4.16 Imperial qts.)
Transmission	
4 Speed	6 U.S. quarts (5.00 Imperial qts.)
Select-O-Speed	12 U.S. quarts (10.00 Imperial qts.)
Hydraulic Reservoir	8 U.S. quarts (6.66 Imperial qts.)
Rear Axle	Series 601-D—8 U.S. quarts (6.66 Imperial qts.) Series 801-D—11½ U.S. quarts (9.58 Imperial qts.)
Steering-Gear Housing	1½ pounds

ENGINE

Type.....	4 cylinder, in-line, overhead valve
Bore	Series 601-D—3.562 inches Series 801-D—3.90 inches
Stroke	3.60 inches
Displacement	Series 601-D—144 cu. inches Series 801-D—172 cu. inches

Compression Ratio	Series 601-D—16.8 to 1 Series 801-D—16.8 to 1
Firing Order	1-2-4-3
Idle Speed	675 R.P.M.
Maximum Speed (no load).....	4-Speed Transmission—2230 R.P.M. Select-O-Speed Transmission—2430 R.P.M.
Sleeves	Series 801-D Cast iron, dry type Series 601-D—None
Pistons	Aluminum alloy
Tappet Clearance (intake and exhaust—hot).....	.014 to .016 inch

COOLING SYSTEM

Type	Pressure
Fan	Two blade
Thermostat	Starts to open—177 to 182° F. Fully open—197 to 202° F.

FUEL SYSTEM

Type	Direct Injection
Governor	Centrifugal
Injection Pump.....	Single cylinder, opposed plunger opposed type
Pump to Engine Timing.....	601-D—26° 801-D—18°

ELECTRICAL SYSTEM

Generator	Two brush shunt wound
Capacity	20 amps., 300 watts
Generator Regulator	Relay type
Battery	12 volt—135 ampere hours
Terminal Grounded	Neg.
Starter Motor	12 volt, controlled with safety switch, automatic follow through

CLUTCH

Type	Single plate, 10 inch
Pedal Free Travel	1½ inch

4 SPEED TRANSMISSION

Gear Ratios:	
First Gear	11.00 to 1
Second Gear	9.06 to 1
Third Gear	6.22 to 1
Fourth Gear	2.98 to 1
Reverse Gear	10.50 to 1

SELECT-O-SPEED TRANSMISSION

Gear Ratios:	
First Gear	38.00 to 1
Second Gear	26.70 to 1
Third Gear	25.60 to 1
Fourth Gear	18.00 to 1
Fifth Gear	11.30 to 1
Sixth Gear	8.77 to 1

Seventh Gear	7.62 to 1
Eighth Gear	5.93 to 1
Ninth Gear	3.66 to 1
Tenth Gear	2.47 to 1
Reverse—One Gear	12.80 to 1
Reverse—Two Gear	8.65 to 1

HYDRAULIC SYSTEM

Type	Live action
Maximum Pressure	2000 p.s.i.
Pump:	
Type	Piston
Drive	Gear
Capacity	4 G.P.M. at 2000 R.P.M. (Engine)
Control	Implement position or constant draft

POWER STEERING SYSTEM (Optional)

Type	External Linkage
Maximum Pressure (Relief Valve Setting)	725 p.s.i.
Pump:	
Type	Roller Vane
Drive	Belt
Capacity	5 g.p.m. at 650 p.s.i. at 1600 r.p.m.
Cylinder	2 Twelve Inch Stroke Booster Cylinders
Steering Gear	Integral Steering Gear and Valve

REAR AXLE

Type	Semi-floating
Ratio	Series 601-D—6.67 to 1 Series 801-D—7.17 to 1

BRAKES

Type	Internal expanding
Control	Mechanical
Width	1½ inch
Drum Size	14-inch diameter
Pedal Free Travel	¾ inch

AMERICAN PETROLEUM INSTITUTE OIL CLASSIFICATION

Classification	Type of Service
DG or MIL-L-2104A	Not recommended for tractor operation.
DM or Supplement 1 (S-1)	Satisfactory for general tractor operation.
DS or (Series 3)	Satisfactory for all types of operation and strongly recommended when any one or a combination of the following conditions may be encountered: <ol style="list-style-type: none"> 1. High air temperatures 2. Intermittent operation at low temperature 3. Fuel contains high sulfur content.

CONTENTS

	PAGE
STANDARD AND OPTIONAL EQUIPMENT.....	2
FOREWORD	3
TRACTOR MODEL AND SERIAL NUMBER.....	4
CONTROLS AND INSTRUMENTS.....	5
Tractor Seat	6
Light Switch	6
Starter Switch	6
Gear Shift Lever	6
Select-O-Speed Shift Lever	7
Starter Button	7
Throttle Control	7
Oil Pressure Gauge	7
Temperature Gauge	7
Fuel Gauge	7
Charge Indicator Light	7
Lubrication Light	7
Clutch Pedal	8
Inching Pedal	8
Brake Pedals	8
Brake Pedal Locks	8
Power Take-Off Lever	9
PTO Control Knob	9
Engine PTO Speed Shift Lever.....	10
Ground Speed PTO Shift Lever.....	10
Drive Line Disengagement Strap.....	10
Hydraulic Selector Lever	10
Hydraulic Lift Control Lever	11
Proof-Meter	11
OPERATION	13
Pre-Starting Check	14
Fuel	14
Break-In Procedure	14

	PAGE
FOUR-SPEED TRANSMISSION TRACTOR	15
Starting The Tractor	15
Driving The Tractor	16
Stopping The Tractor	16
SELECT-O-SPEED TRANSMISSION TRACTOR	16
Speed Selector Mechanism	16
Re-positioning The Selector Lever	17
Selector Lever Stops	17
Starting The Engine	18
Driving The Tractor	18
Stopping The Tractor	18
Towing The Tractor	19
The Hydraulic System	19
Implement Position Control	20
Constant Draft Control	20
Hydraulic Piston Pump	20
Attaching Implements	21
Two Hole Hydraulic Lift Rocker	21
Adjustable Top Link	22
Swinging Drawbar	22
Power Take-Off Operation	23
Belt Pulley	25
Wheel Tread Adjustments	26
Front Wheel Tread Adjustment	26
Rear Wheel Tread Adjustment	28
Power Adjusted Rear Wheels	28
Wheel Weight	30
MAINTENANCE	33
Pre-Delivery Inspection	34
50 Hour Inspection	34
Lubrication	34
Service Daily or Every Ten Hours	34
Service Every 100 Hours	36
Service Every 200 Hours	38
Service Every 400 Hours	38
Service Every 600 Hours	39

	PAGE
Lubrication Charts	40, 41
Mechanical Maintenance	42
Cooling System	42
Fuel System	44
Fuel System Adjustments	47
Electrical System	49
Engine	51
Wheels, Brakes and Tires	52
Tractor Storage	55
ACCESSORIES	57
SPECIFICATIONS	59
General	60
Capacities	60
Engine	60
Cooling System	61
Fuel System	61
Electrical System	61
Clutch	61
Transmission	61
Hydraulic System	62
Power Steering System	62
Rear Axle	62
Brakes	62
American Petroleum Institute Oil Classification	62

Mr. Diesel Owner

IMPORTANT

AIR CLEANER SERVICE

- SERVICE OIL CUP DAILY
VERY DUSTY CONDITIONS TWICE DAILY.
- SERVICE BODY MONTHLY—REMOVE AND CLEAN THOROUGHLY WITH SOLVENT. VERY DUSTY CONDITIONS CLEAN AS REQUIRED.
- USE SAME SAE GRADE OIL RECOMMENDED IN CRANKCASE.
- KEEP HOSE CONNECTIONS TIGHT AND INLET SCREEN AND TUBE CLEAN AND FREE OF OIL.

PRE-CLEANER SERVICE

- THE PRE-CLEANER HAS A DIRT LEVEL MARKED ON THE SIDE OF THE CONTAINER AND MUST BE SERVICED AS THE DUST PARTICLES APPROACH THIS LEVEL.

ONLY THE OPERATOR CAN DETERMINE THE EXACT REQUIREMENTS FOR SERVICING THE AIR SYSTEM ON HIS TRACTOR BASED ON THE CONDITIONS UNDER WHICH IT IS OPERATED. BOTH THE AIR CLEANER AND PRE-CLEANER SHOULD BE INSPECTED FREQUENTLY WHEN FIRST OPERATING UNDER DUSTY CONDITIONS TO DETERMINE THE CORRECT SERVICING INTERVAL.